

TecnoLine moduul AA (horizontaal)

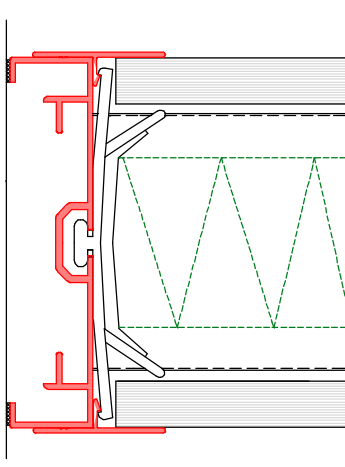

detail C

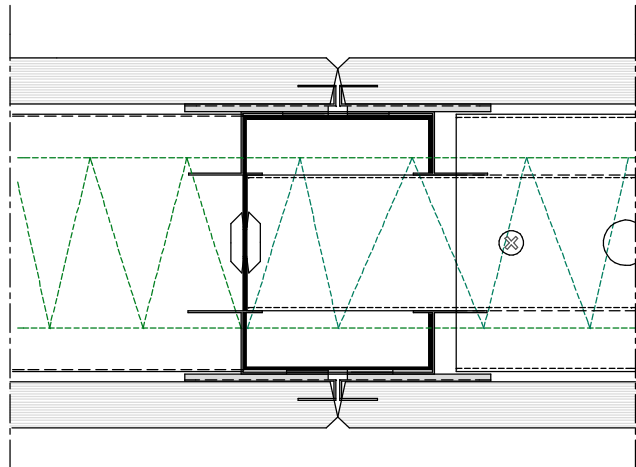

detail D

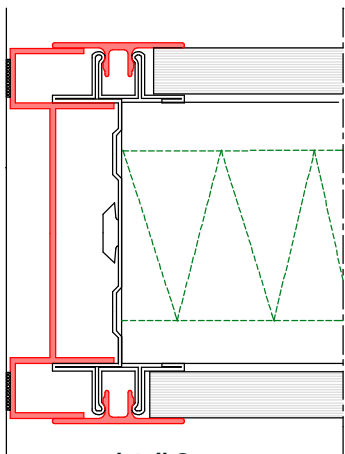

detail C

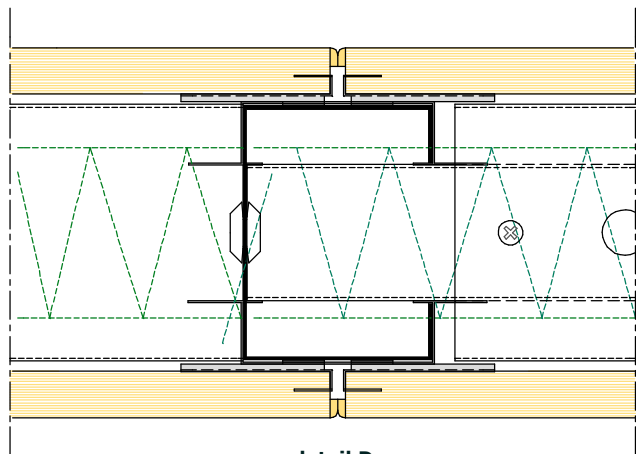

detail D

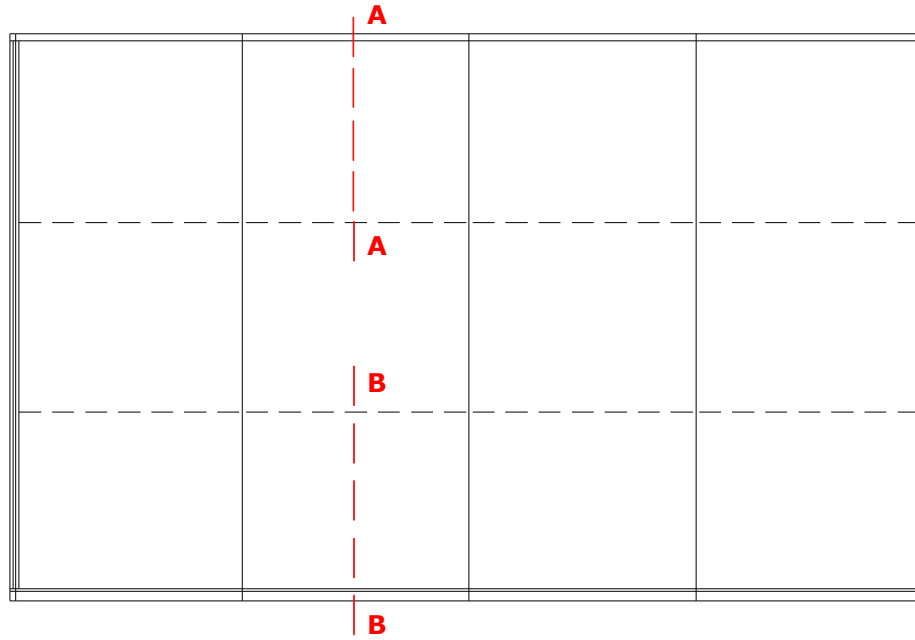

TecnoLine moduul AA (vertikaal)

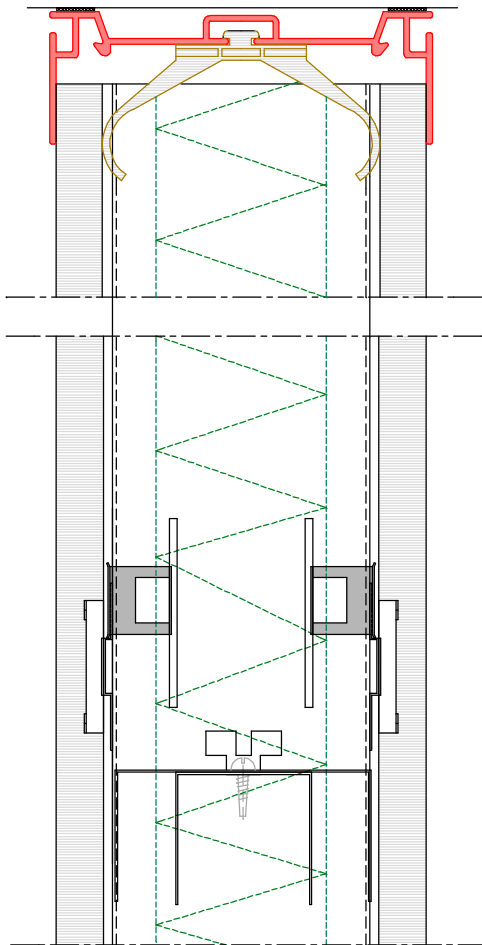

detail A

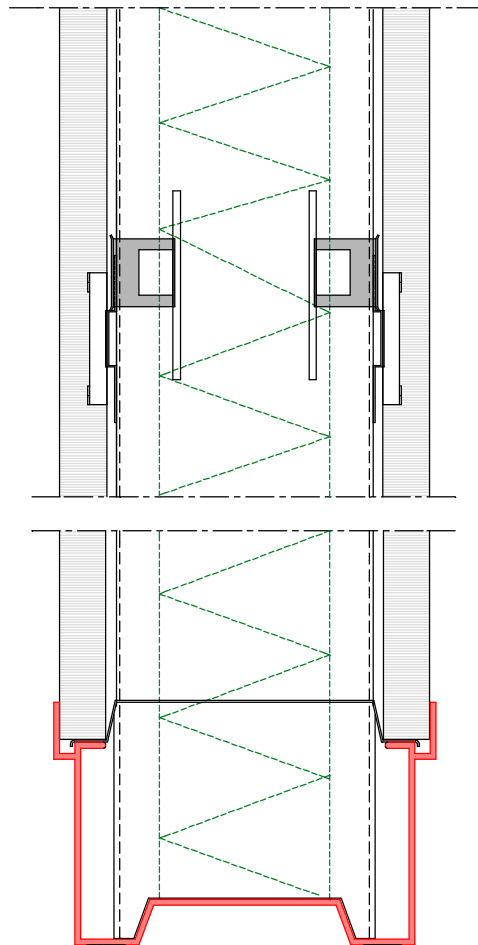

detail B

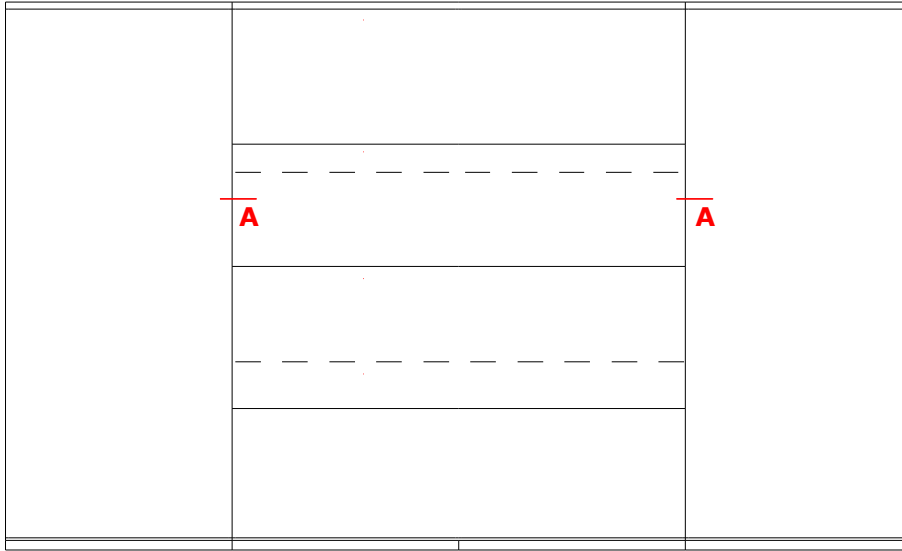

TecnoLine moduul AA4 h.o.h. 2400mm (horizontaal)

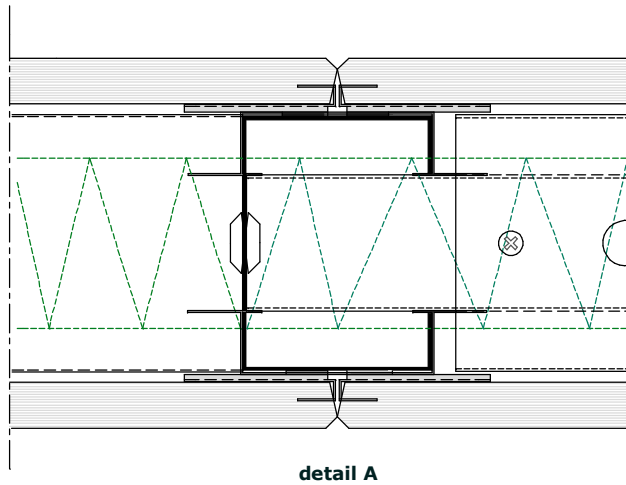

detail A

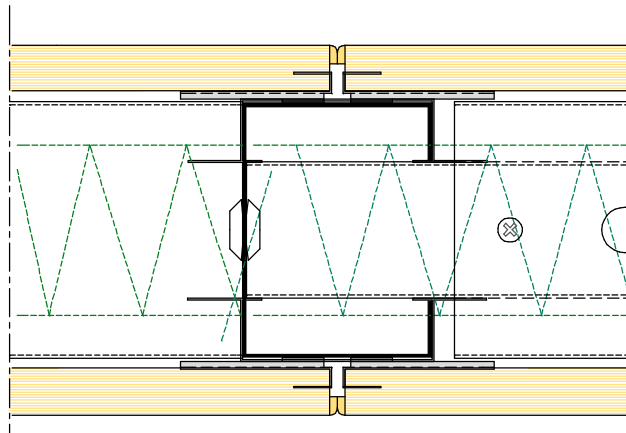

detail A

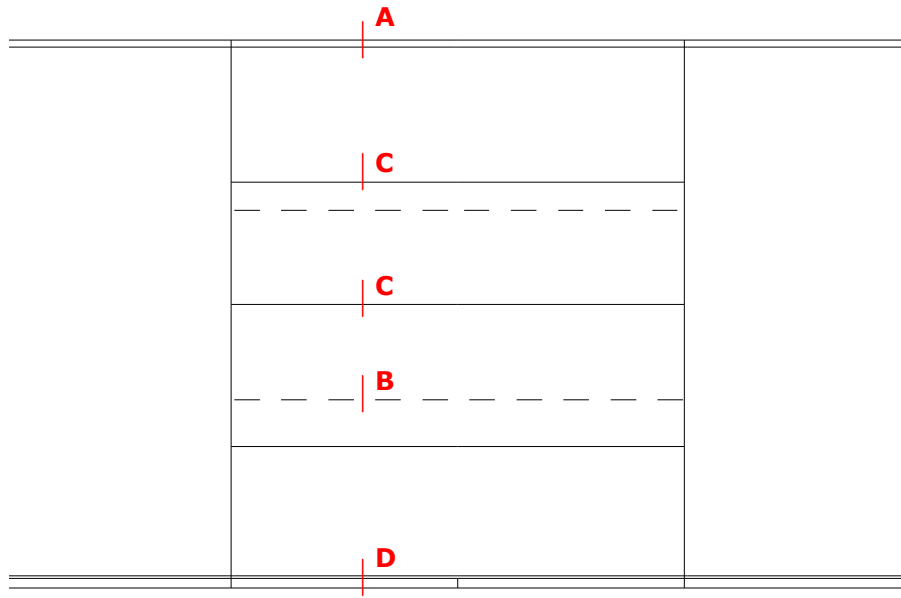

TecnoLine moduul AA4 h.o.h. 2400mm (vertikaal)

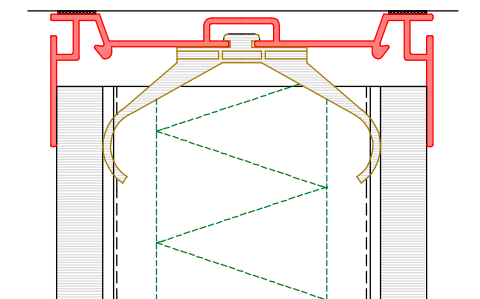

detail A

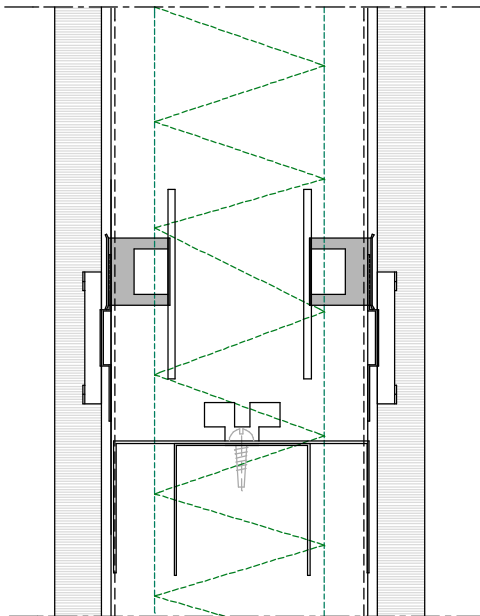

detail B

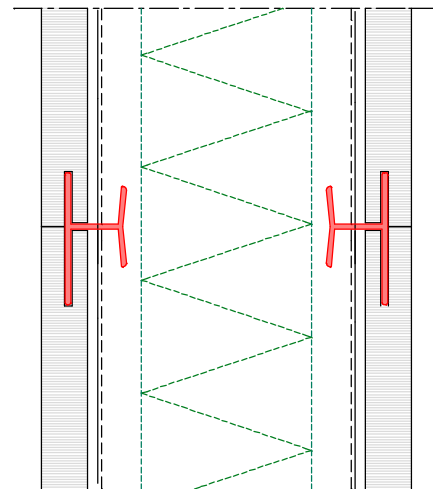

detail C

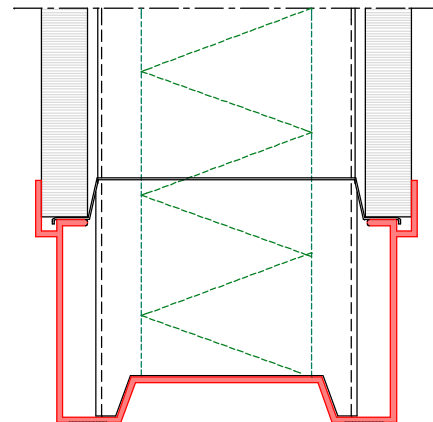

detail D

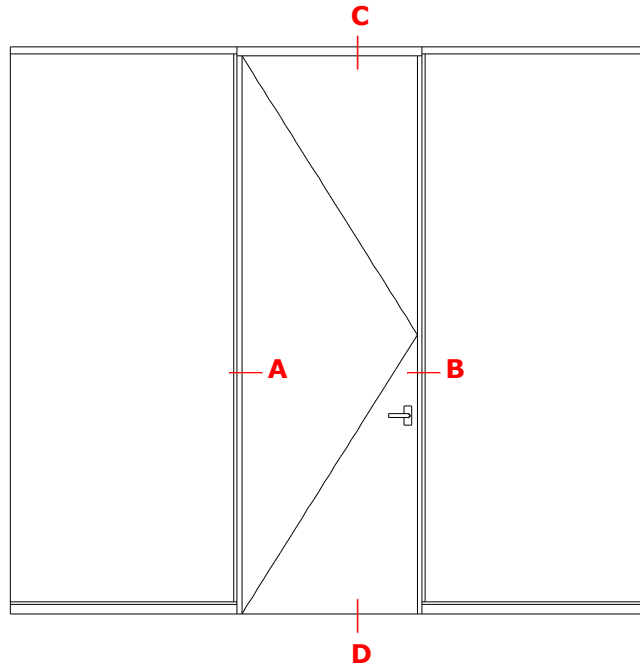

TecnoLine : modul DAW

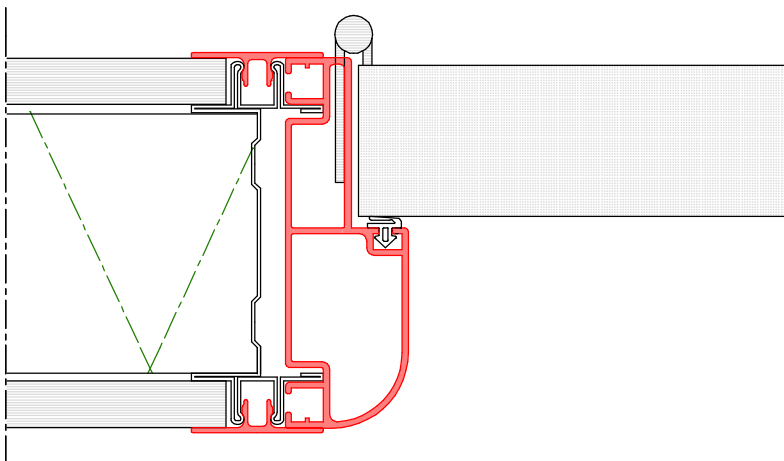

detail A

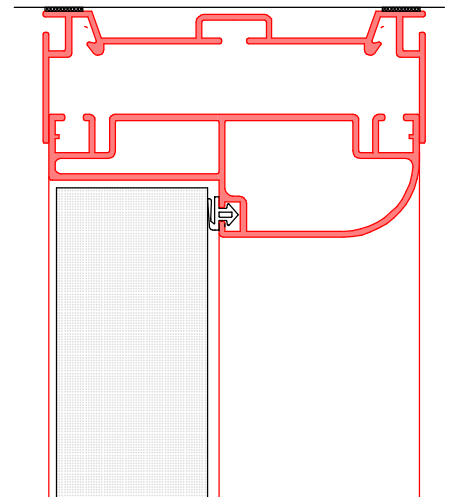

detail C

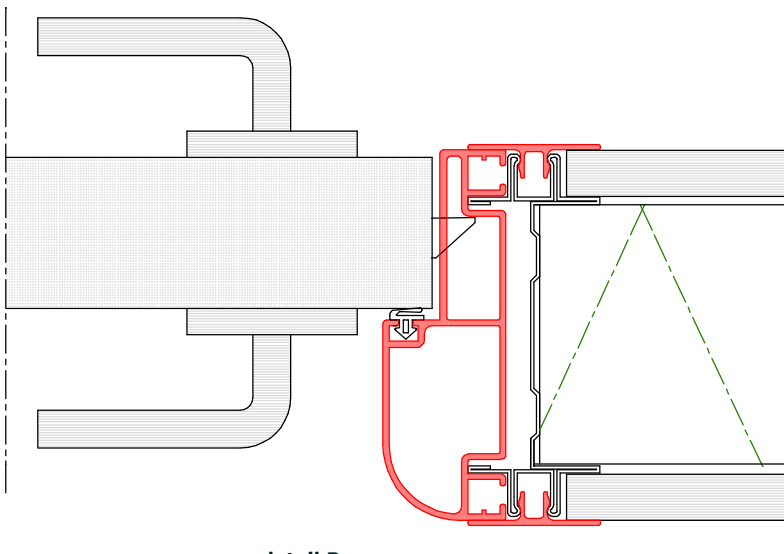

detail B

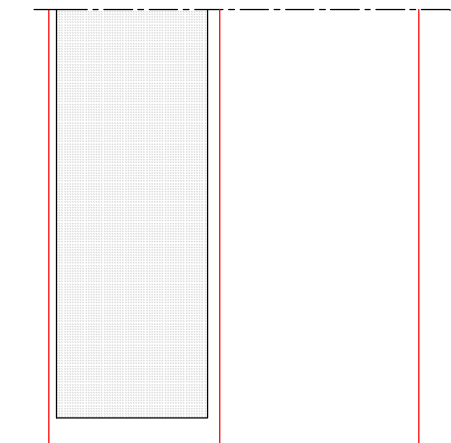

detail D

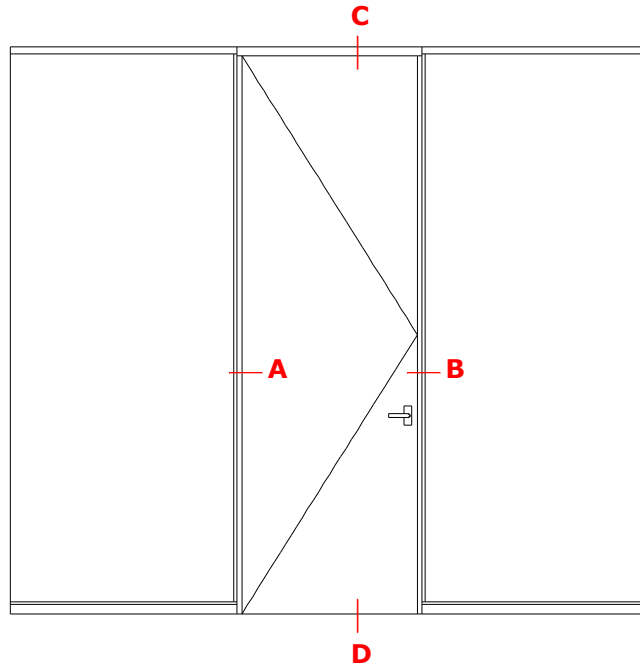

TecnoLine : modul DAW

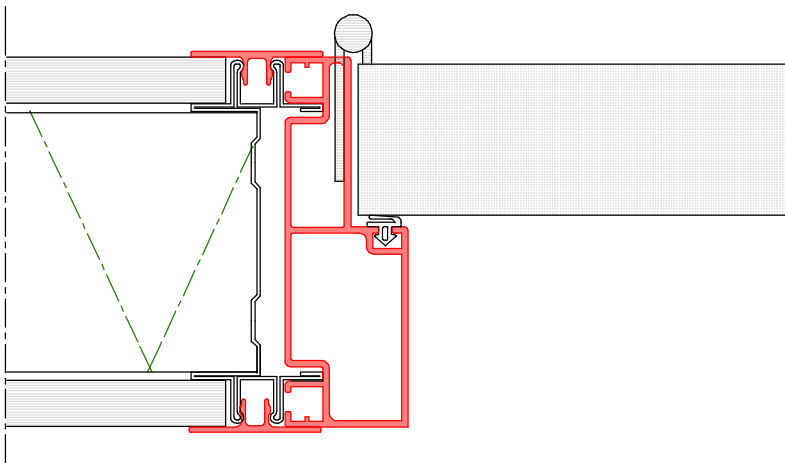

detail A

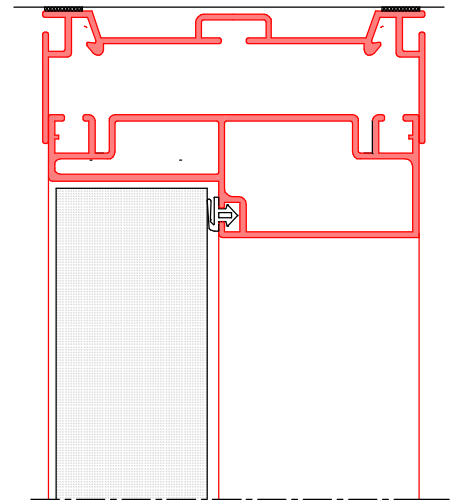

detail C

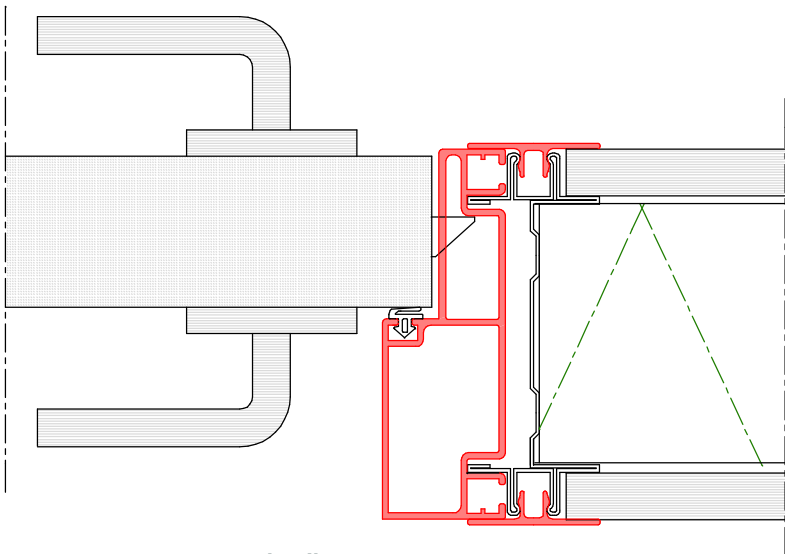

detail B

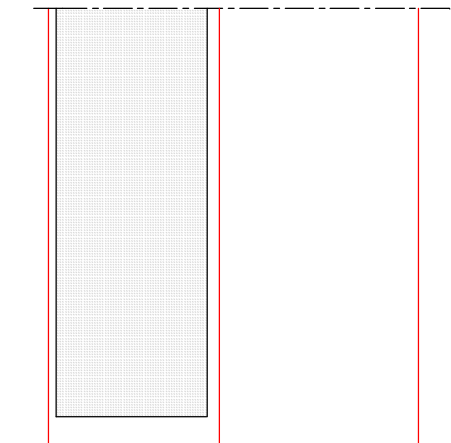

detail D

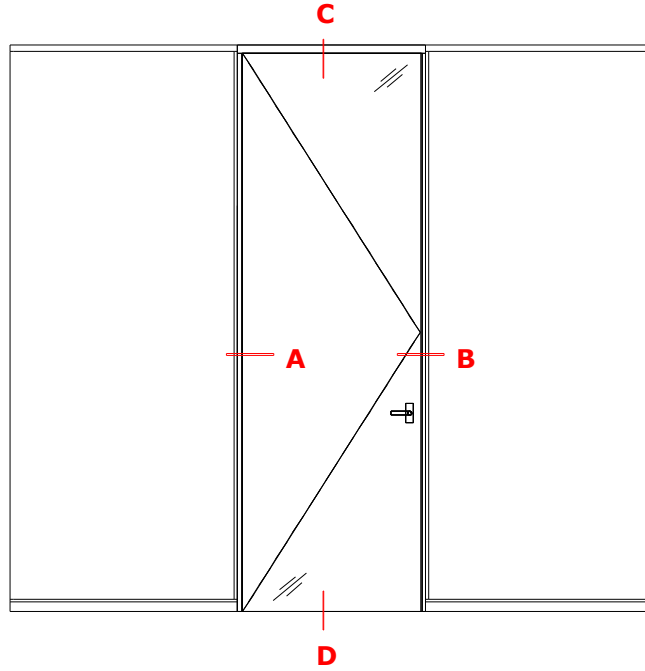

TecnoLine : modulul DAW-HG

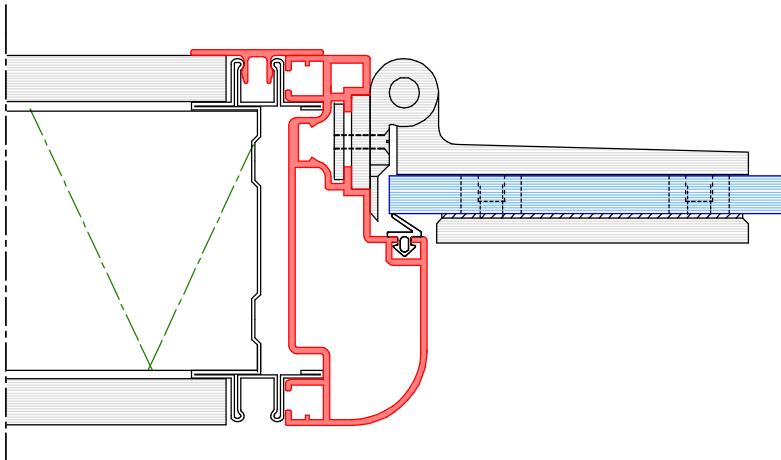

detail A

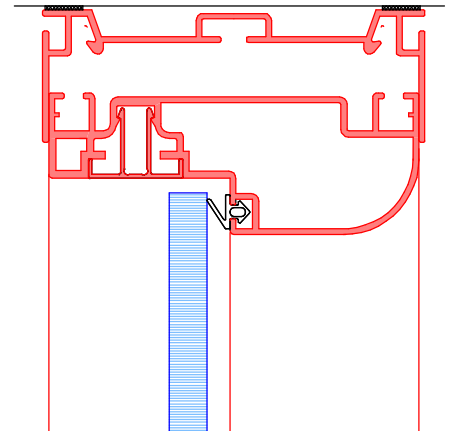

detail C

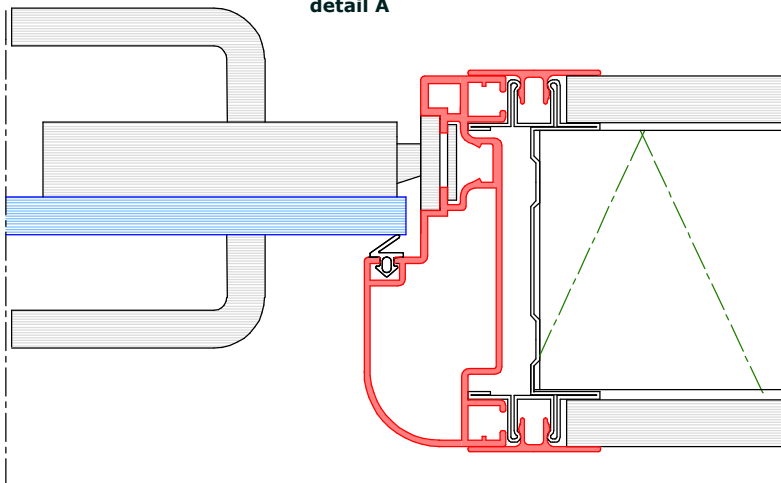

detail B

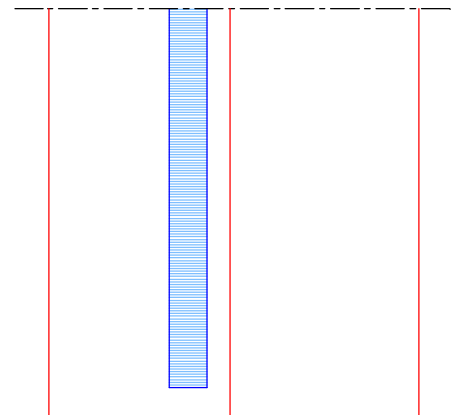

detail D

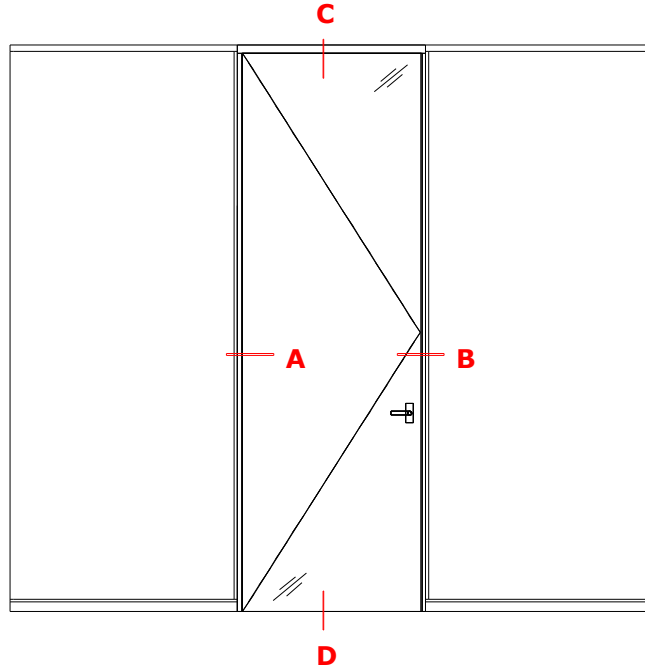

TecnoLine : modul DAW-HG

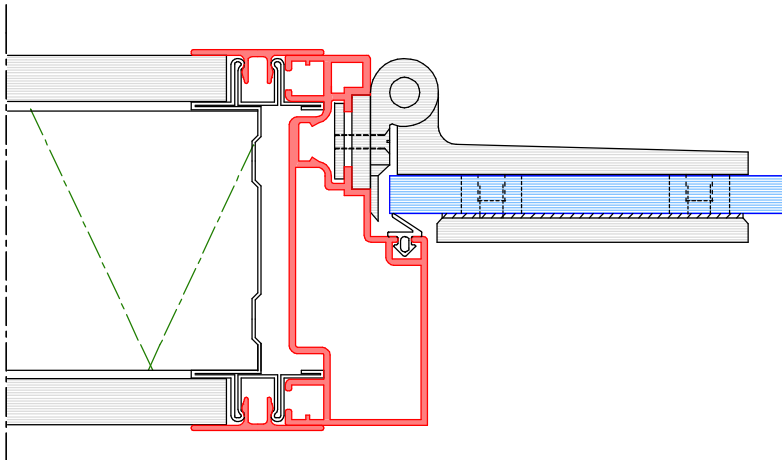

detail A

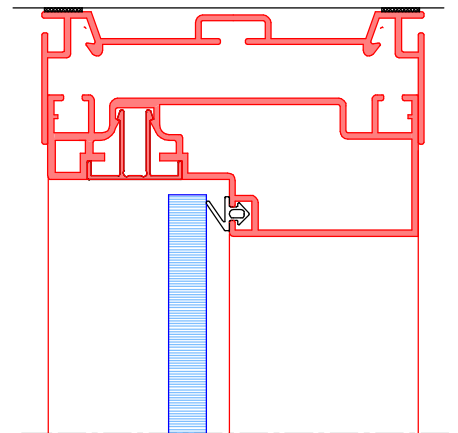

detail C

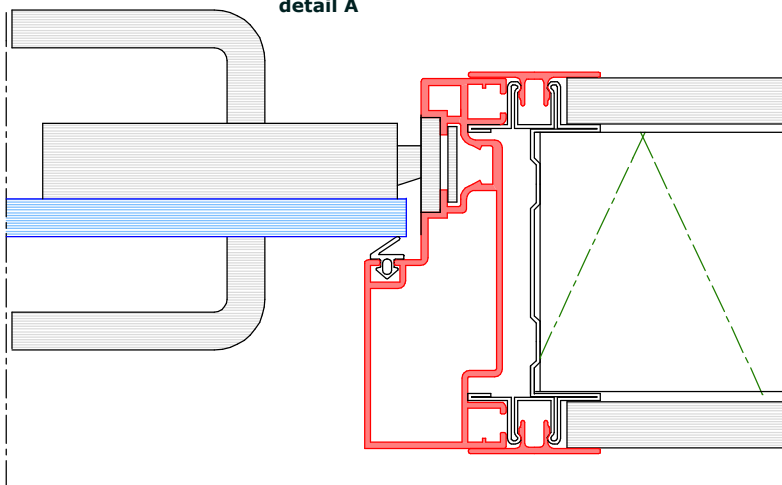

detail B

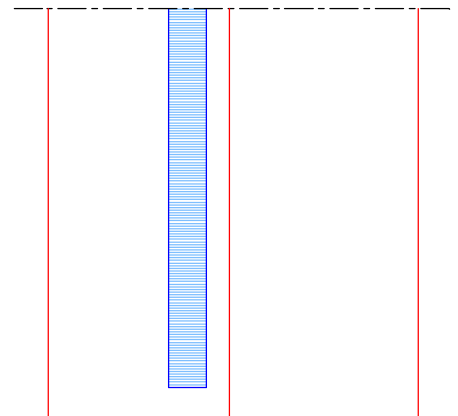

detail D

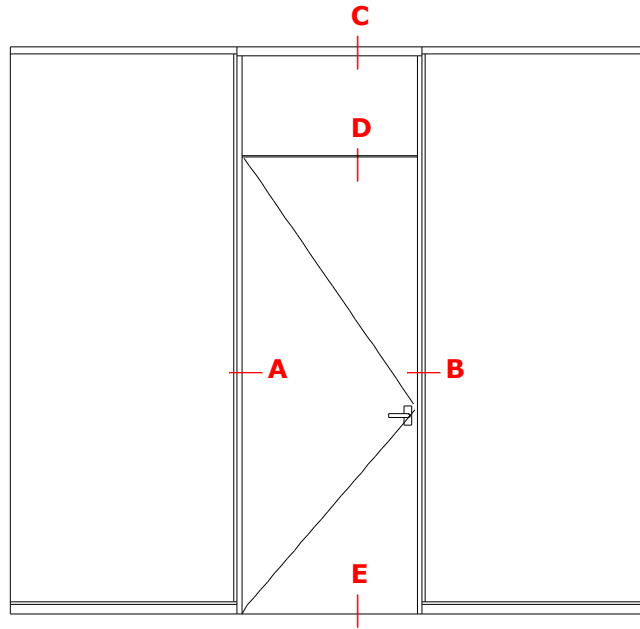

TecnoLine : modul DEE

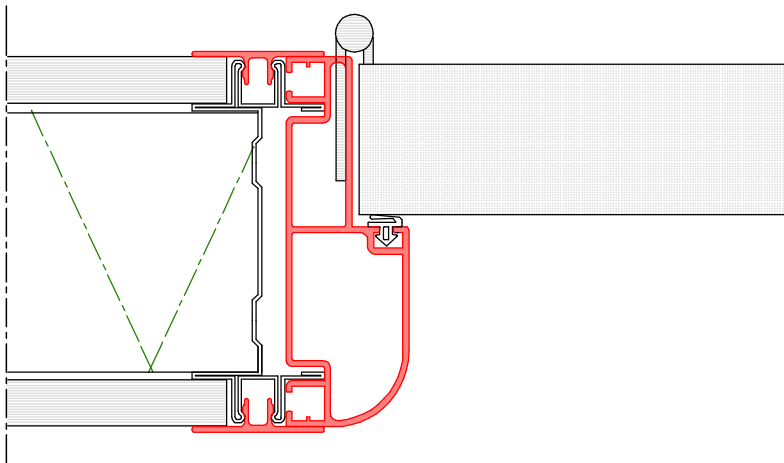

detail A

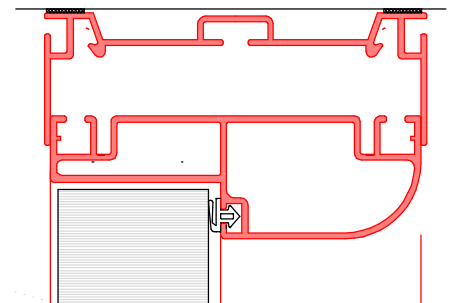

detail C

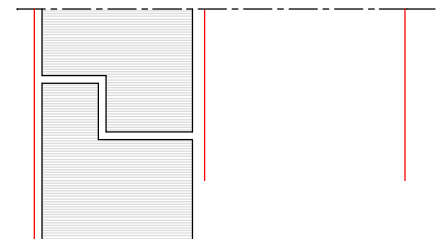

detail D

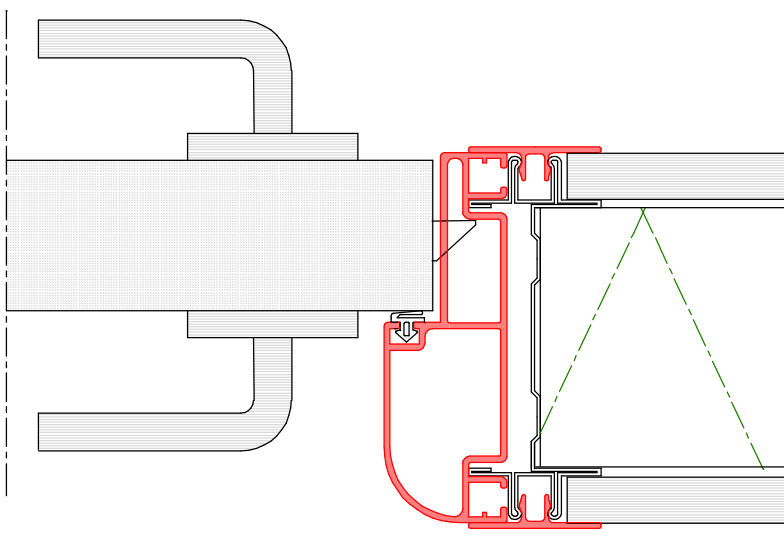

detail B

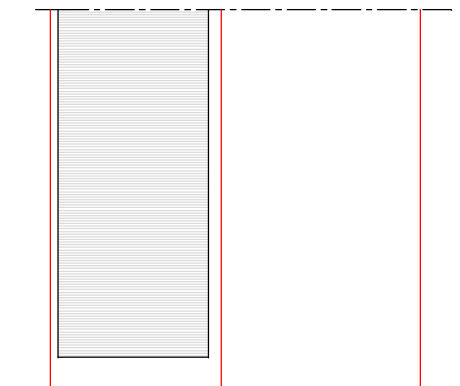

detail E

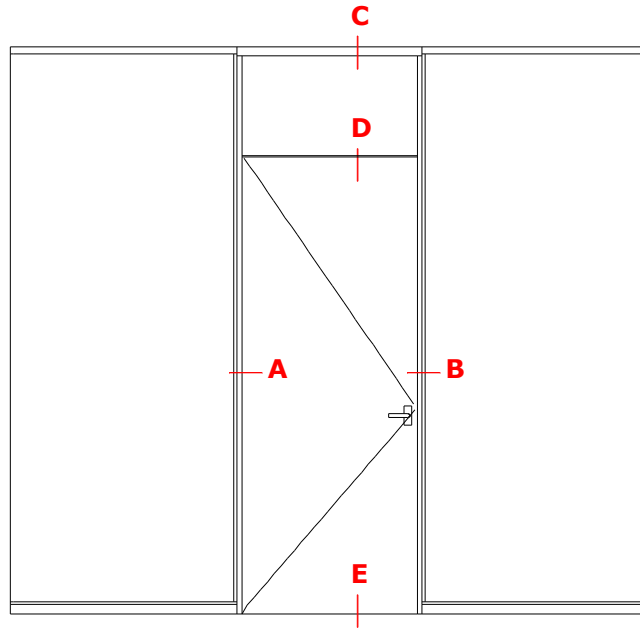

TecnoLine : modul DEE

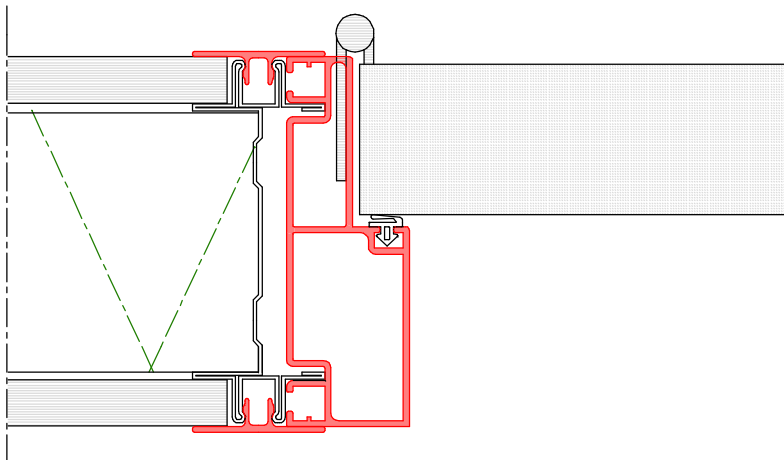

detail A

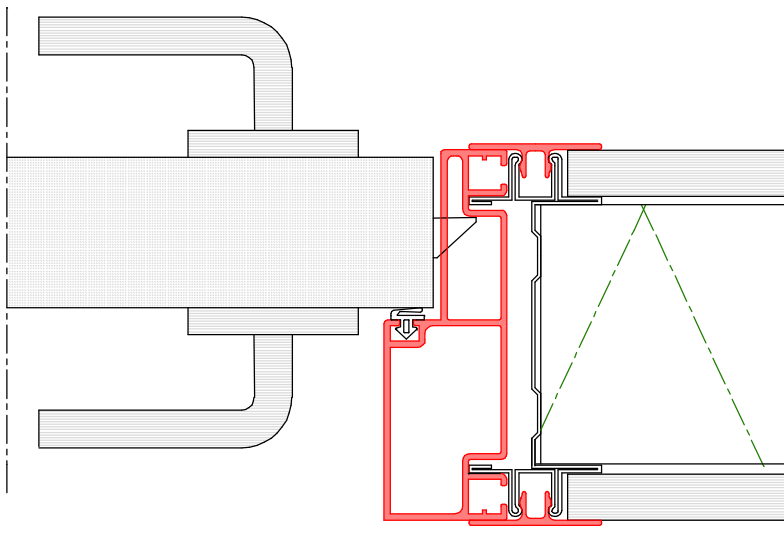

detail B

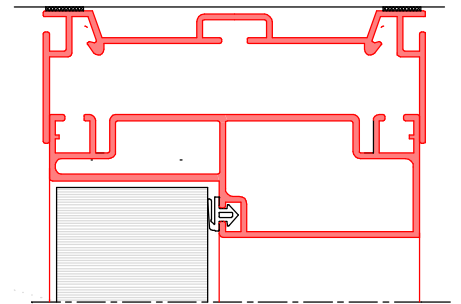

detail C

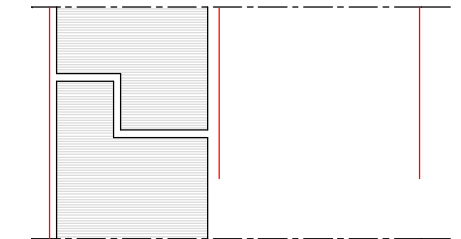

detail D

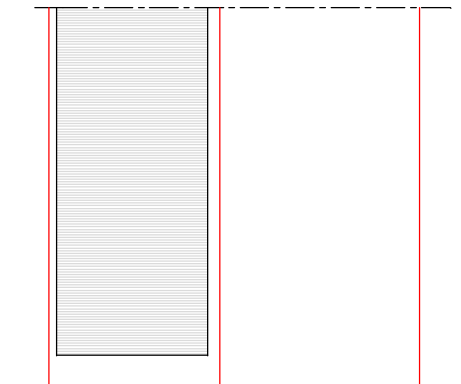

detail E

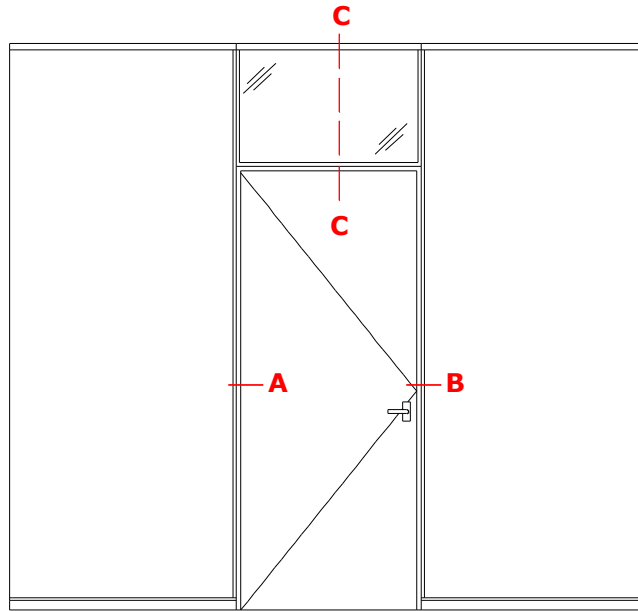

TecnoLine : moduul DFF

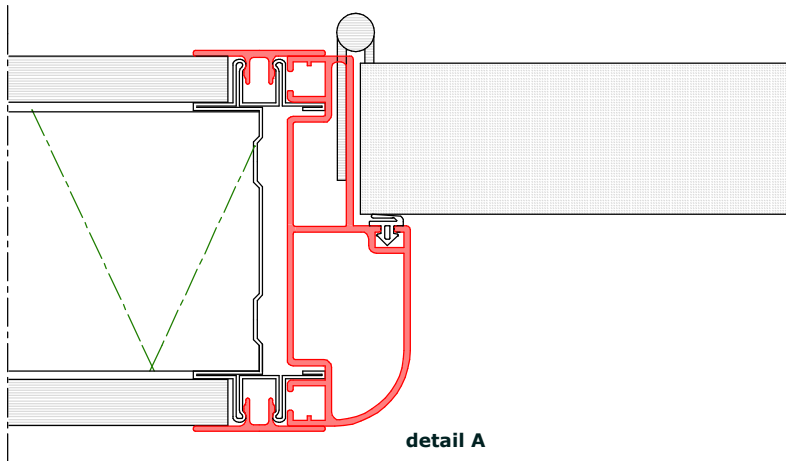

detail A

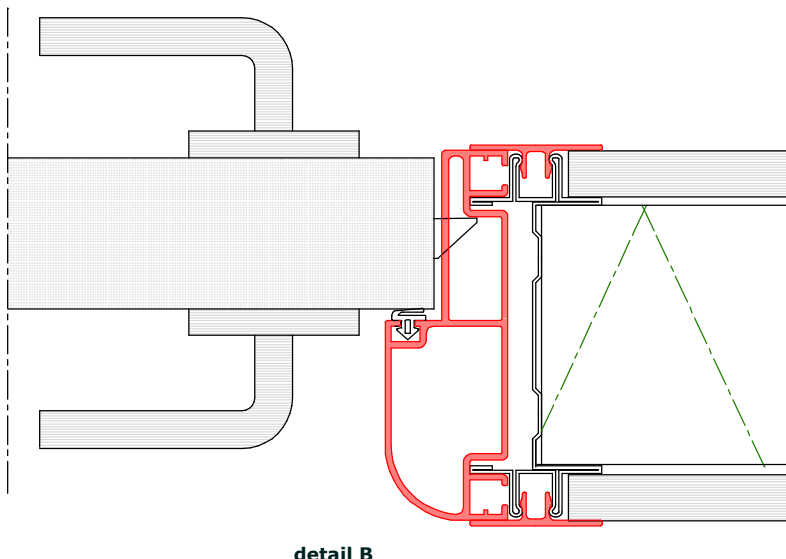
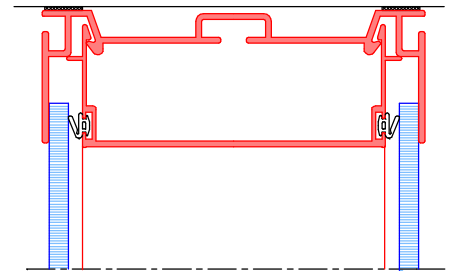

detail B

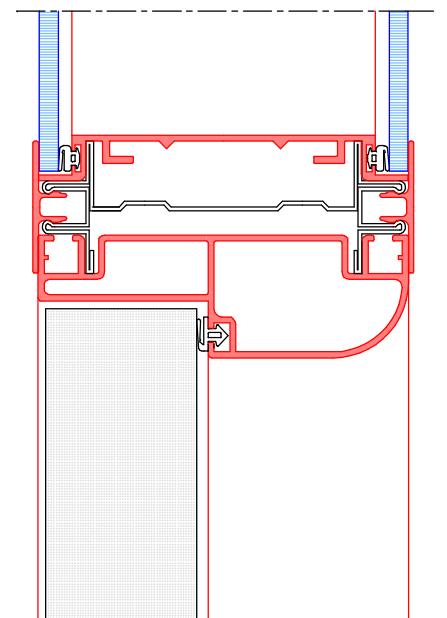

detail C

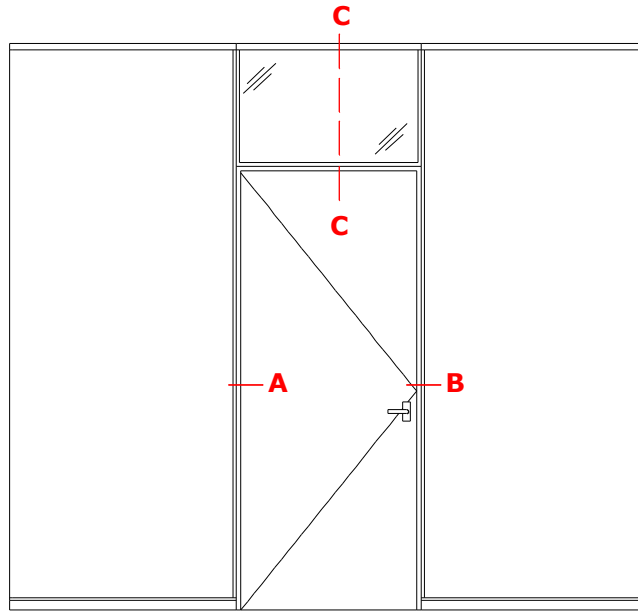

TecnoLine : moduul DFF

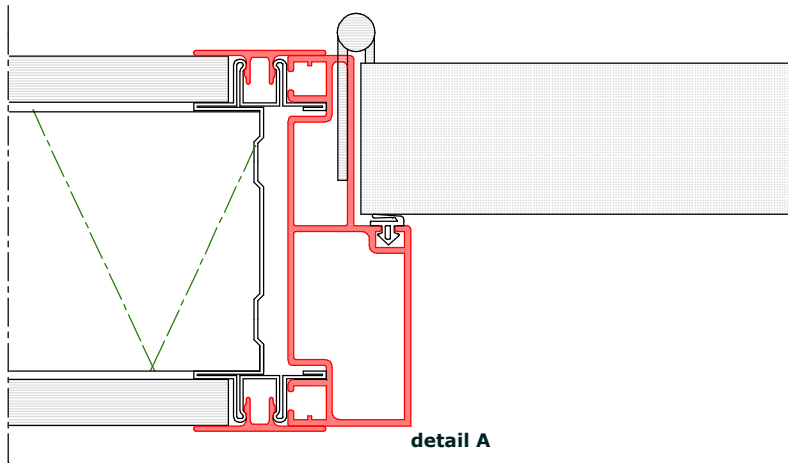

detail A

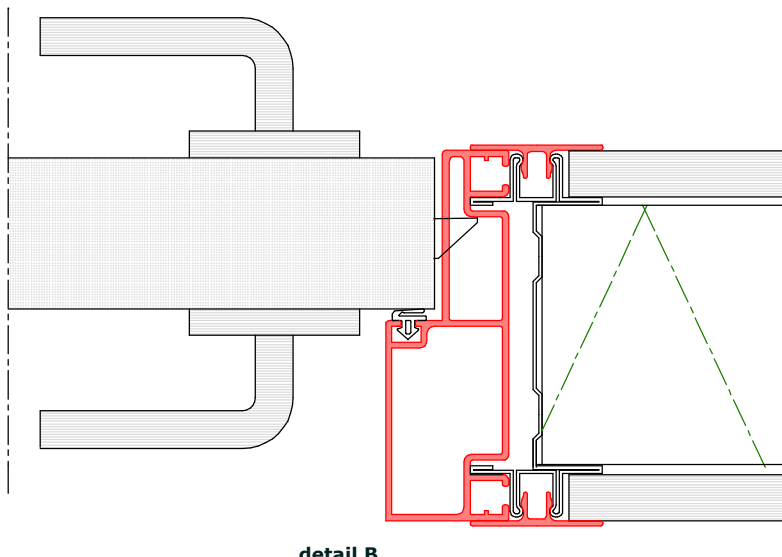
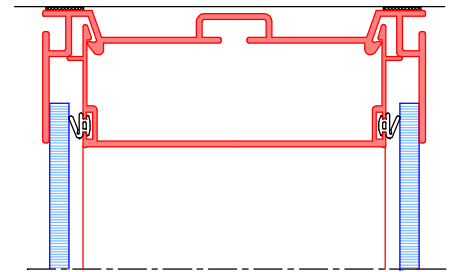

detail B

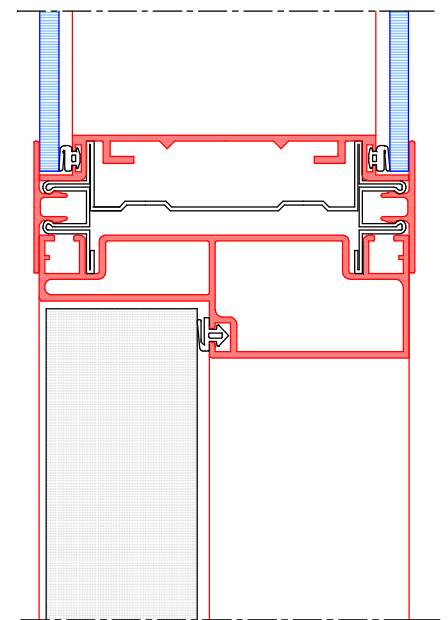

detail C

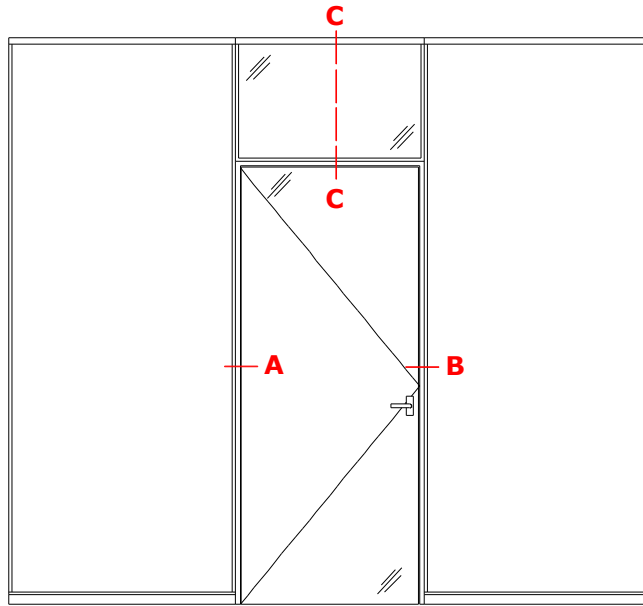

TecnoLine : moduul DFF-HG

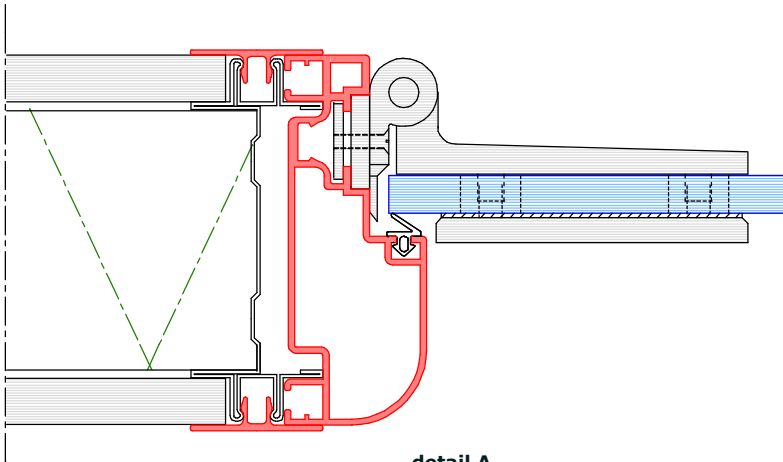

detail A

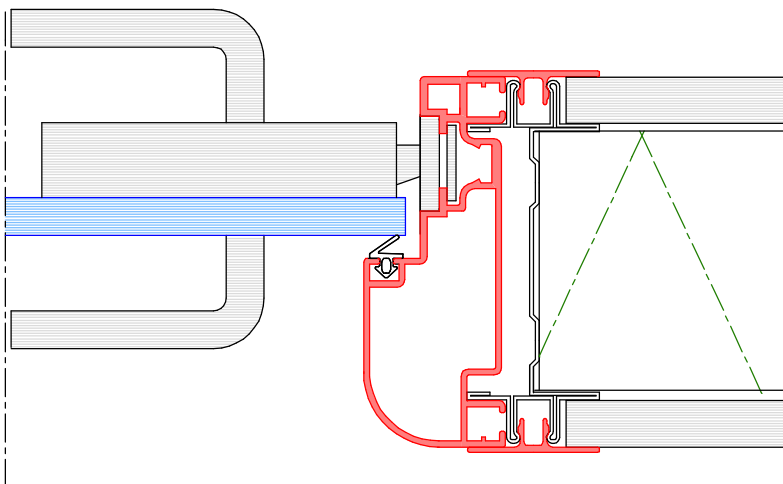

detail B

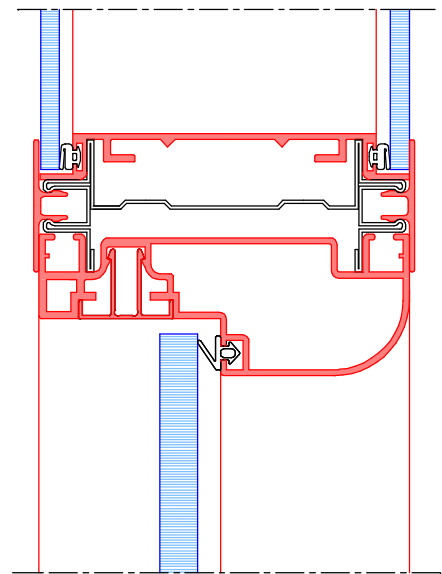
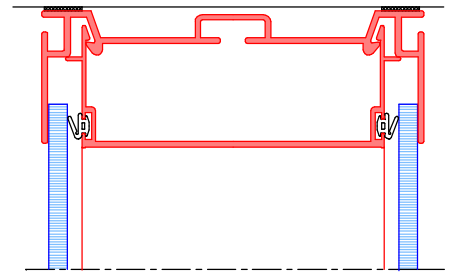

detail C

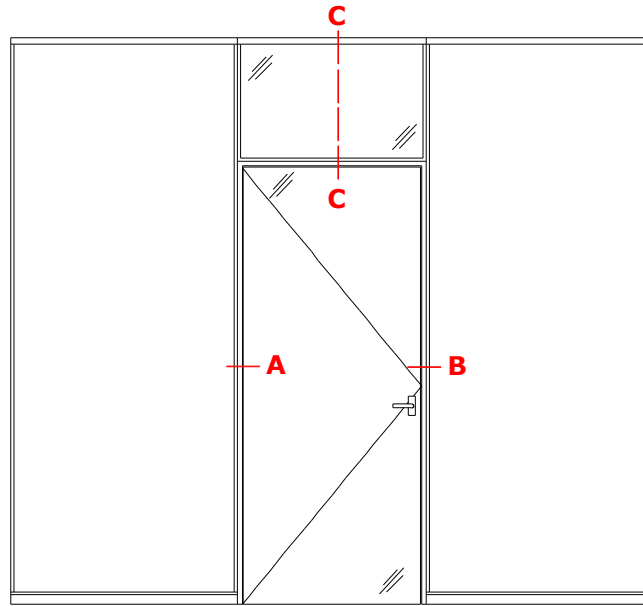

TecnoLine : moduul DFF-HG

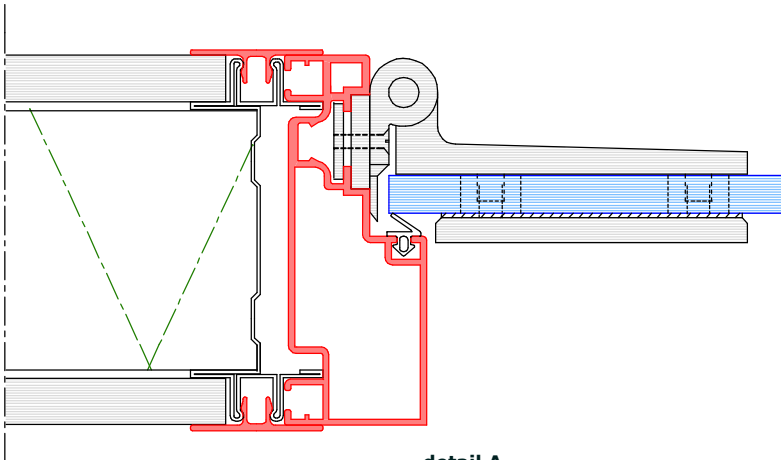

detail A

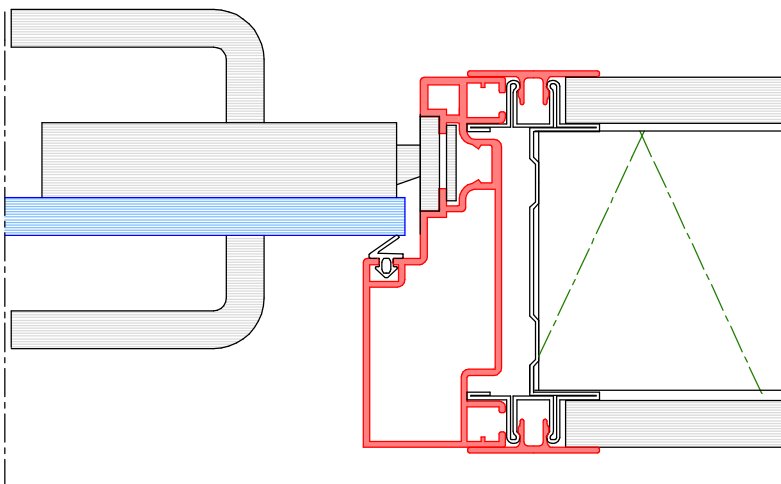

detail B

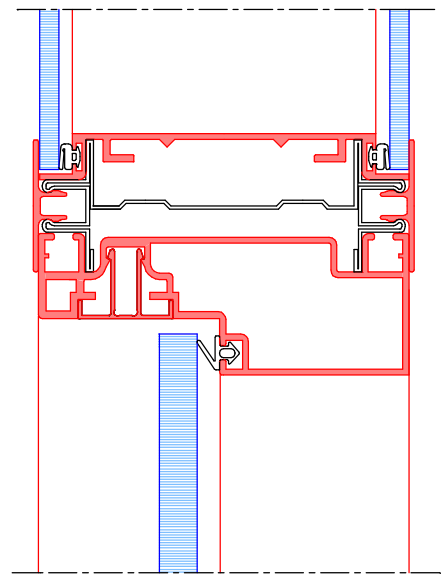
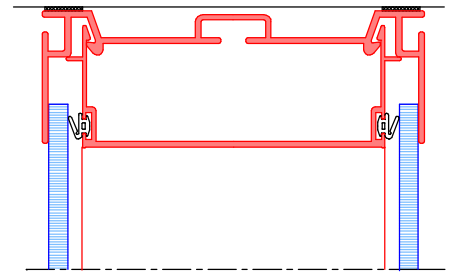

detail C

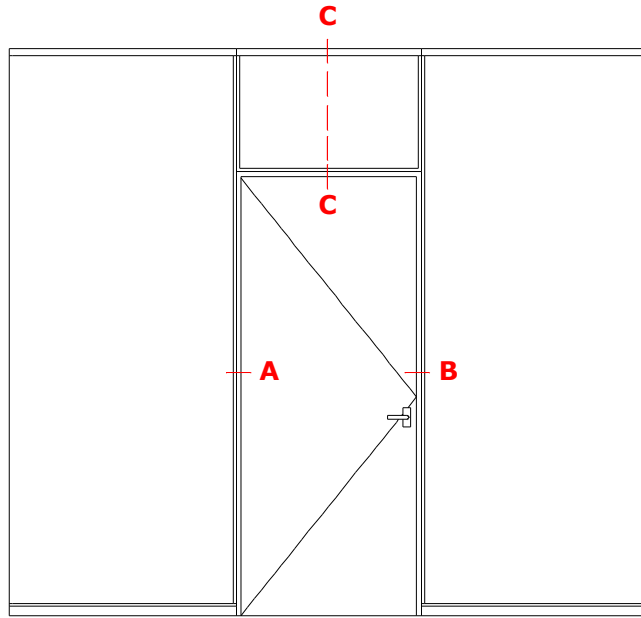

TecnoLine : moduul DGG

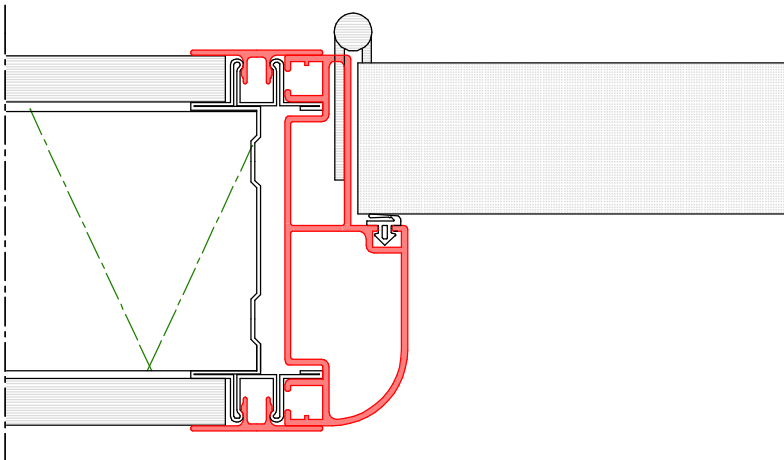

detail A

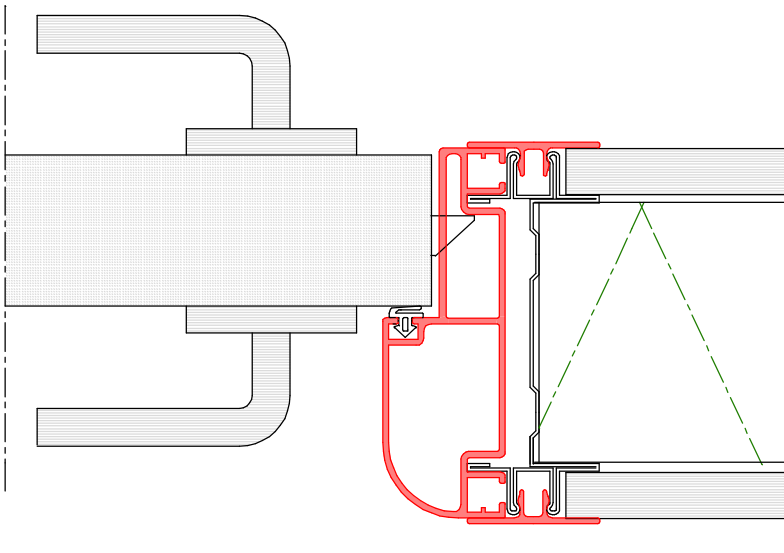

detail B

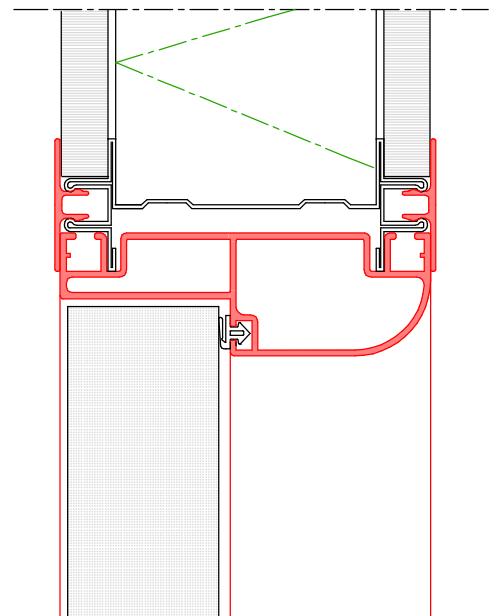
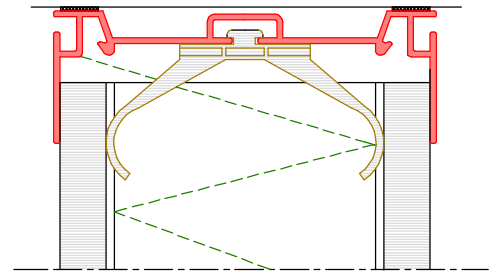

detail C

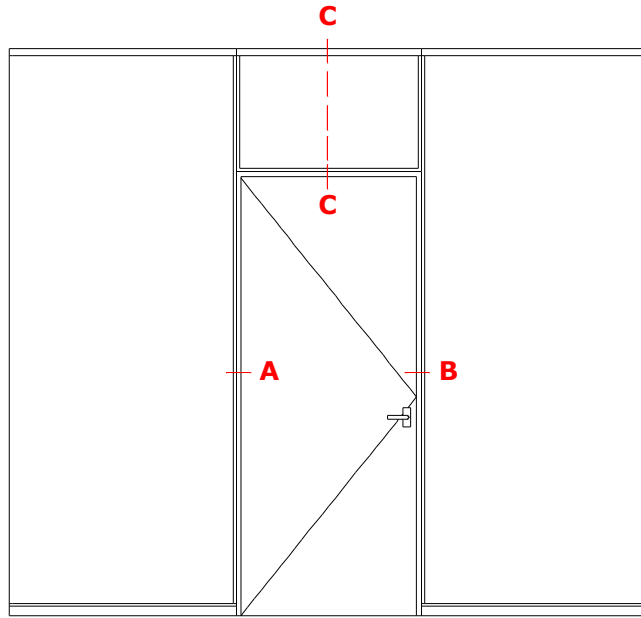

TecnoLine : moduul DGG

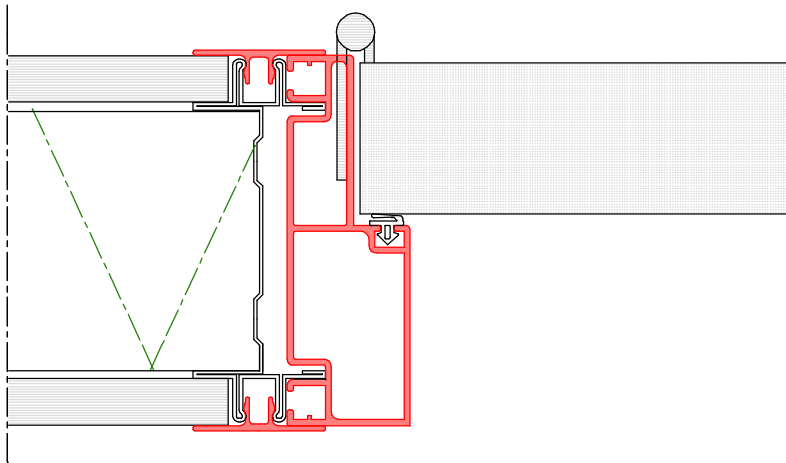

detail A

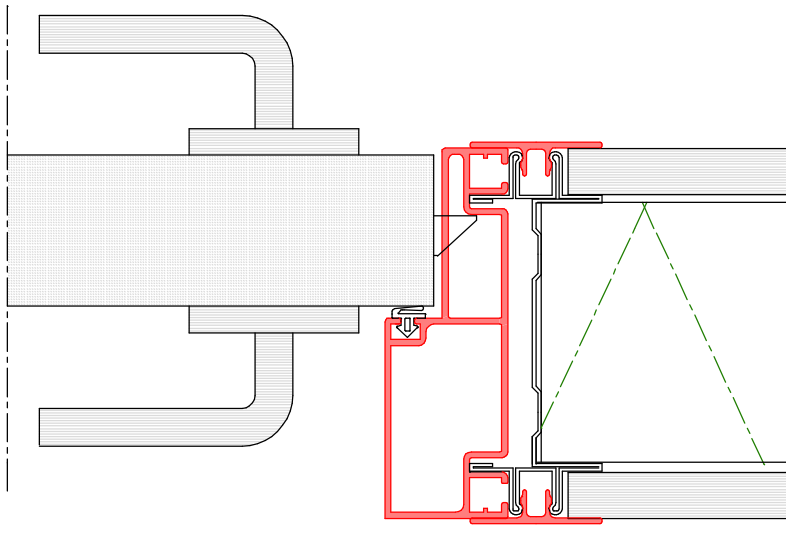

detail B

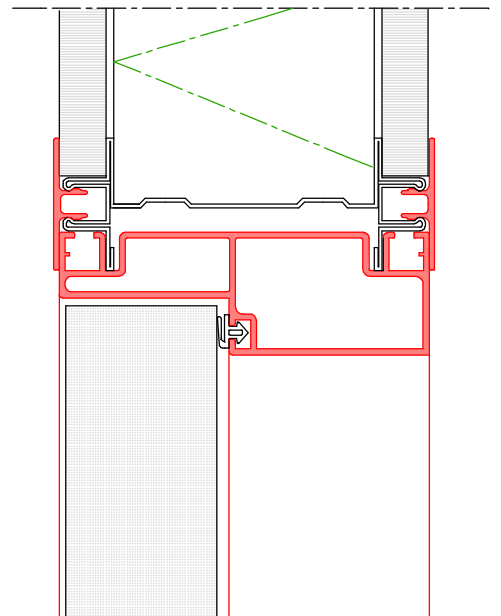
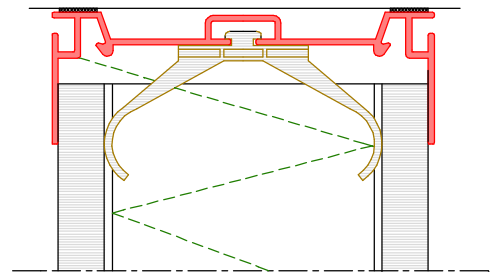

detail C

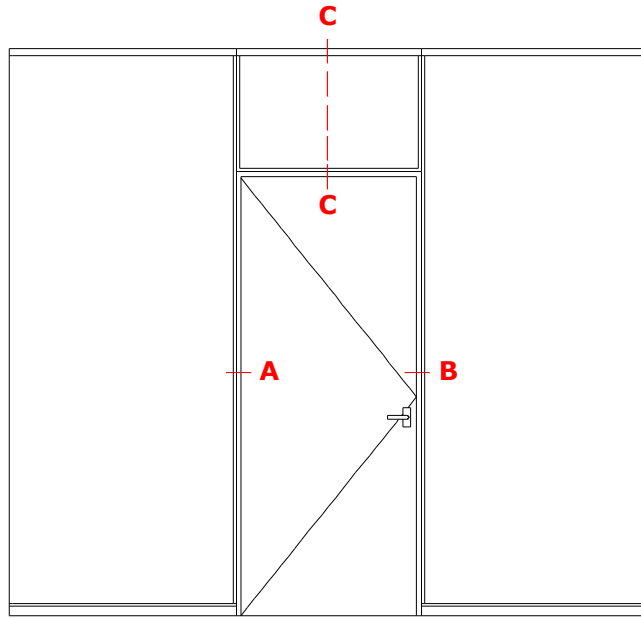

TecnoLine : modul DGG-FR

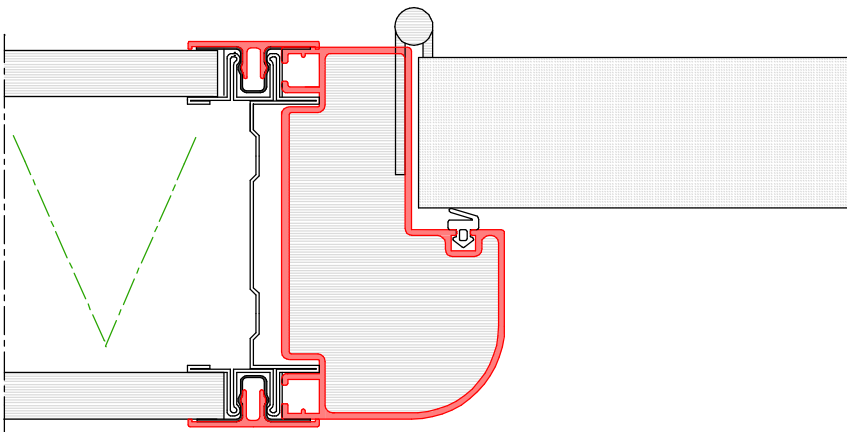

detail A

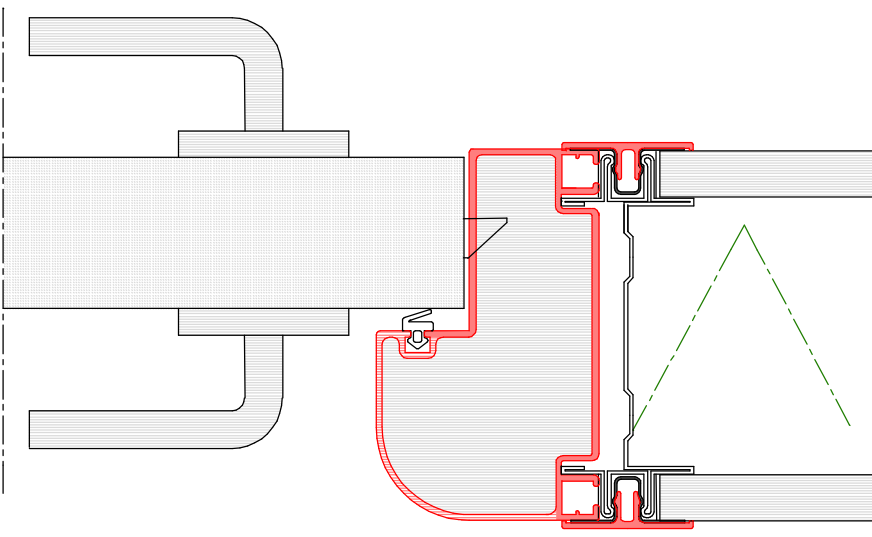

detail B

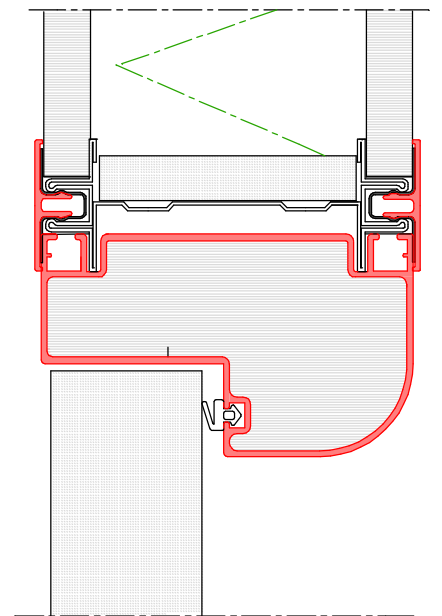
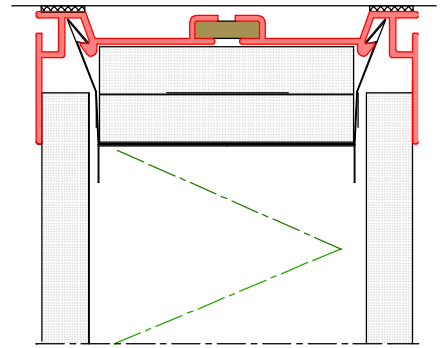

detail C

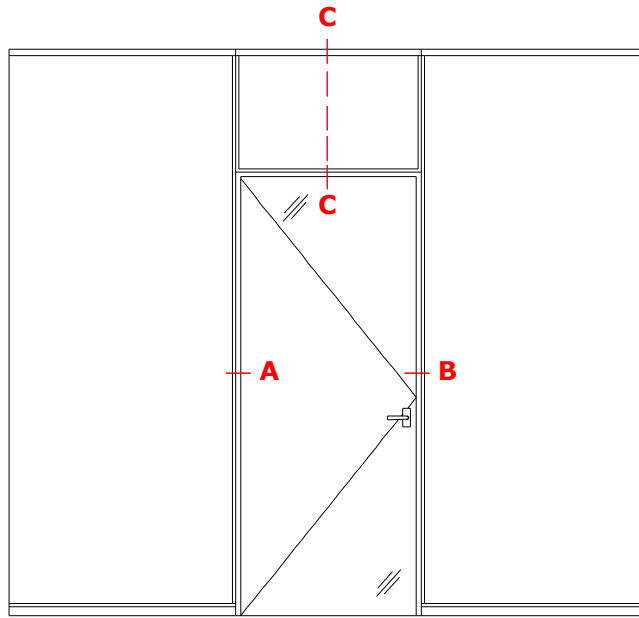

TecnoLine : moduul DGG-HG

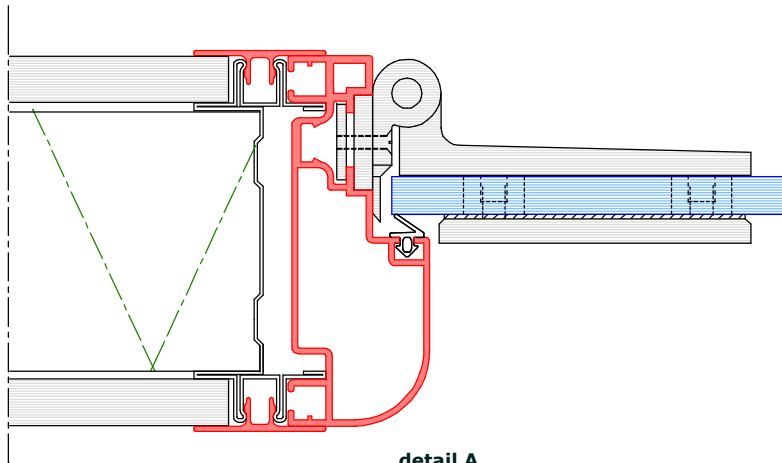

detail A

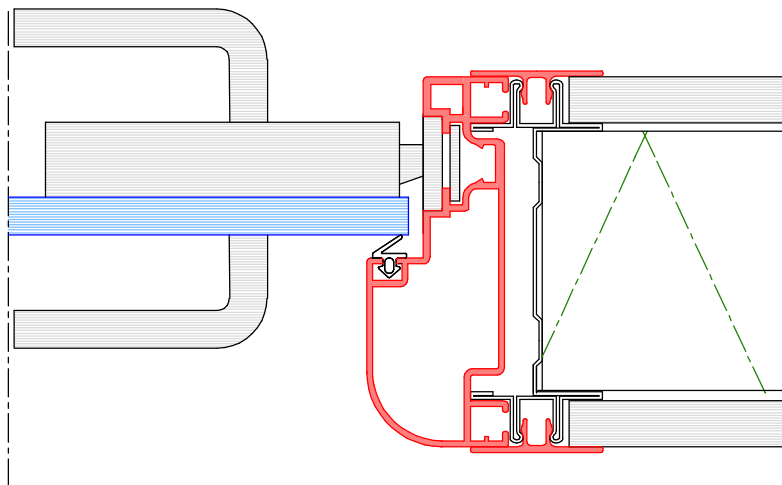

detail B

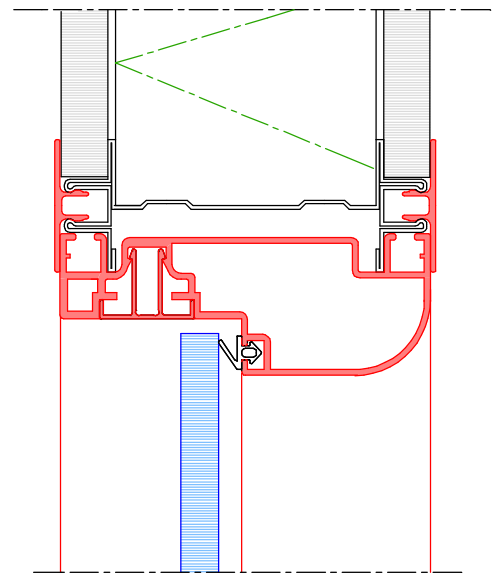
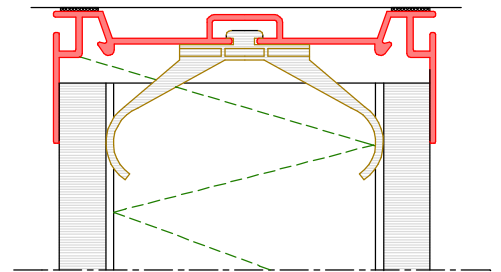

detail C

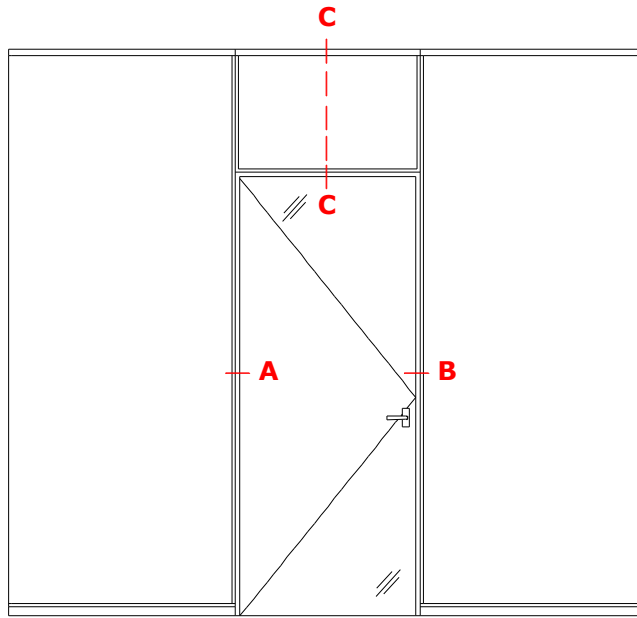

TecnoLine : moduul DGG-HG

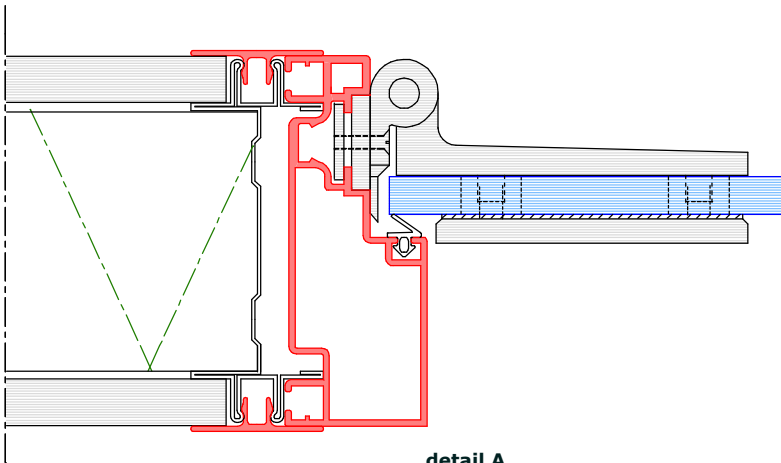

detail A

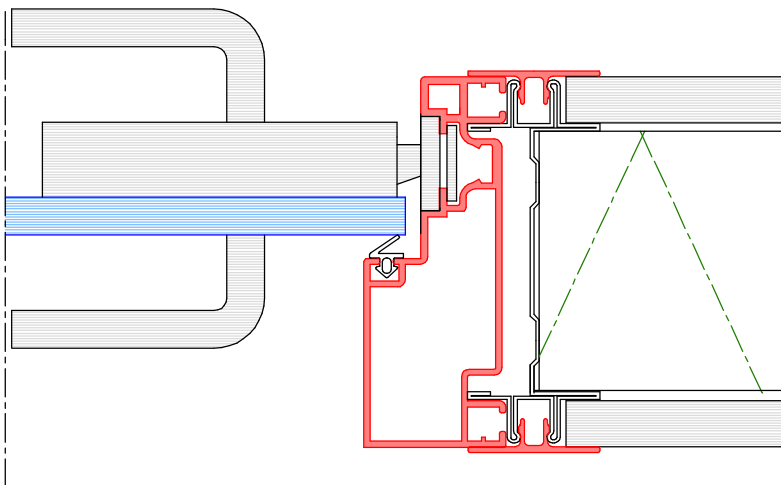

detail B

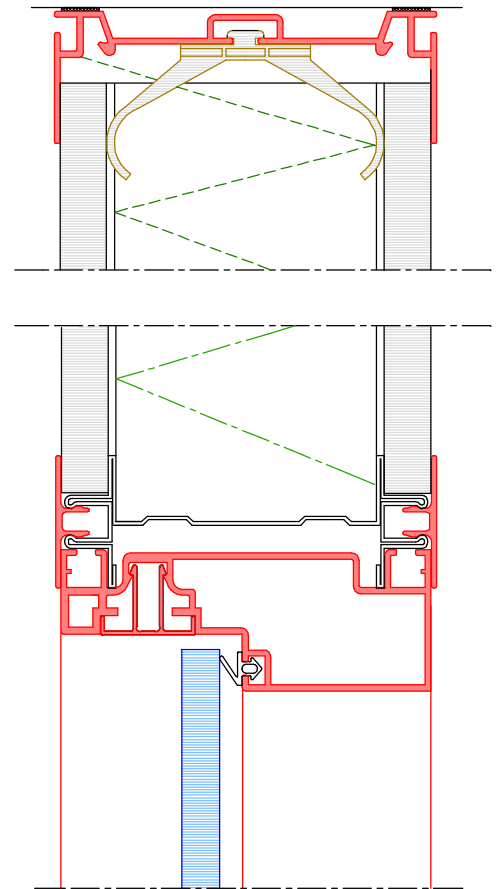

detail C

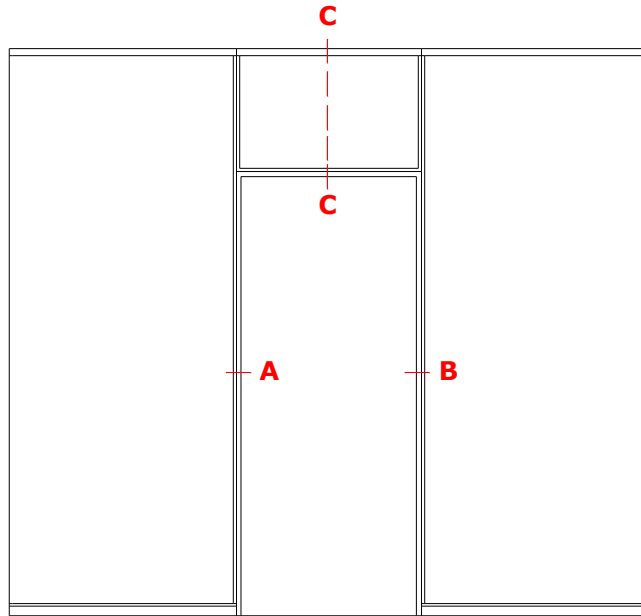

TecnoLine : moduul DGG-DL

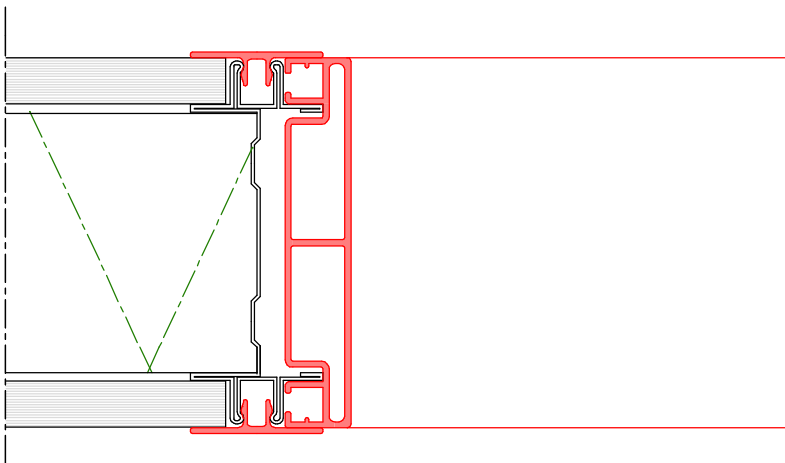

detail A

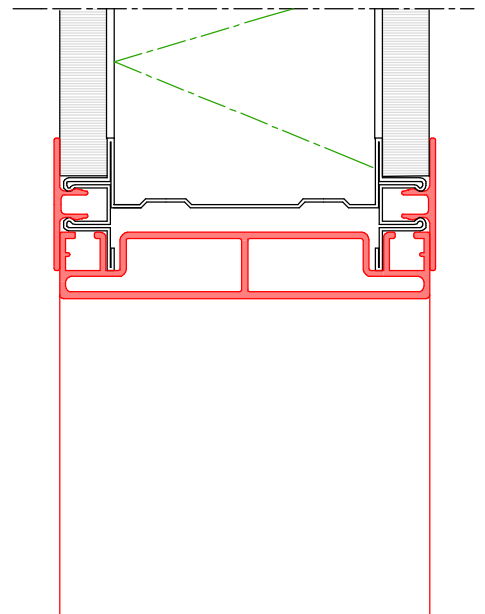
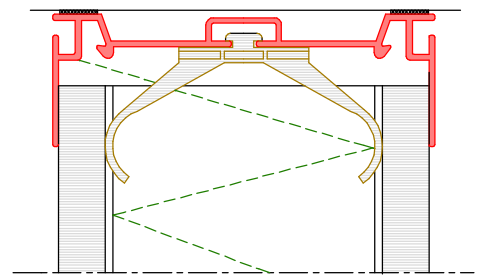

detail C

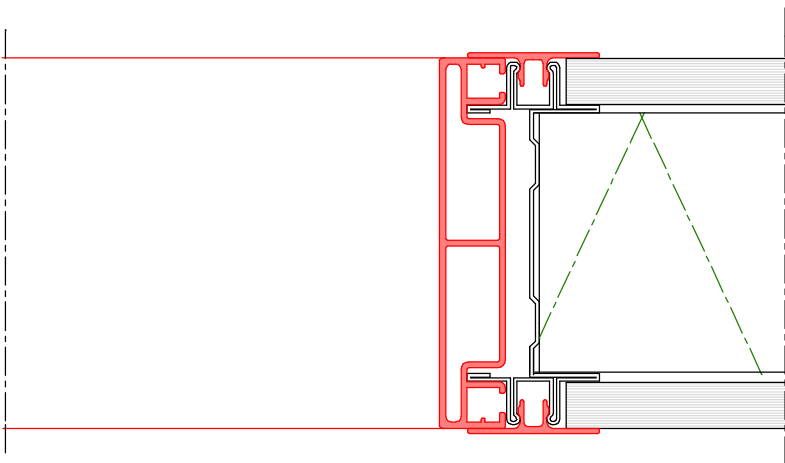

detail B

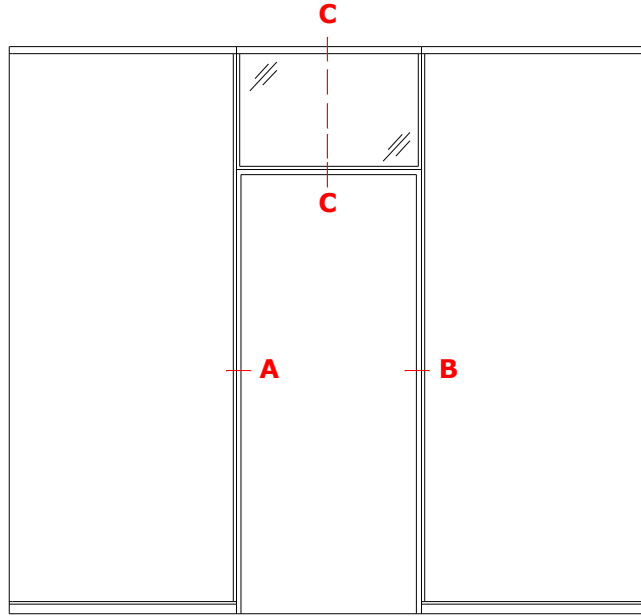

TecnoLine : modul DFF-DL

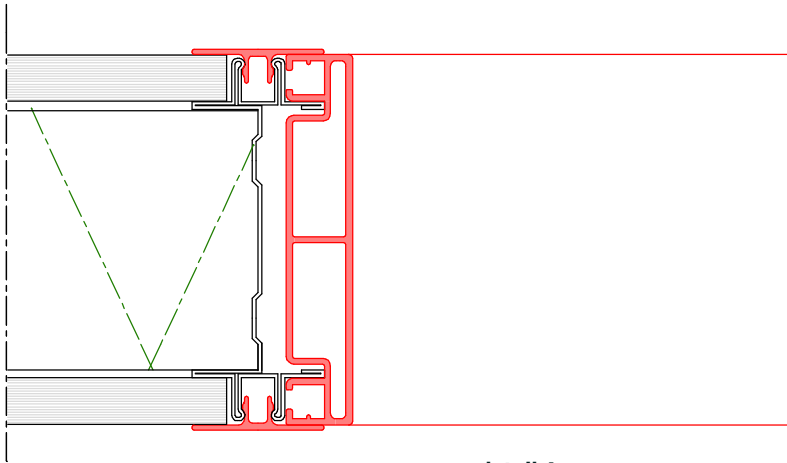

detail A

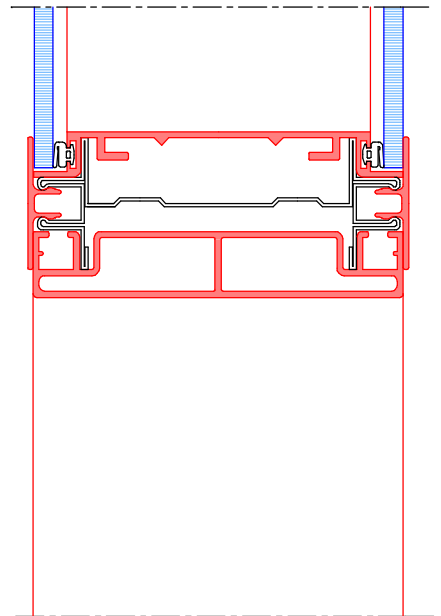
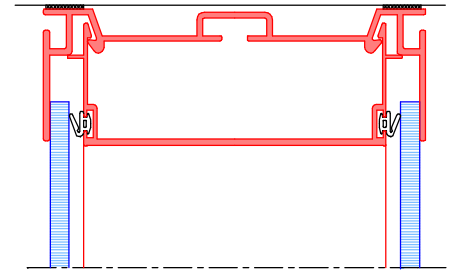

detail C

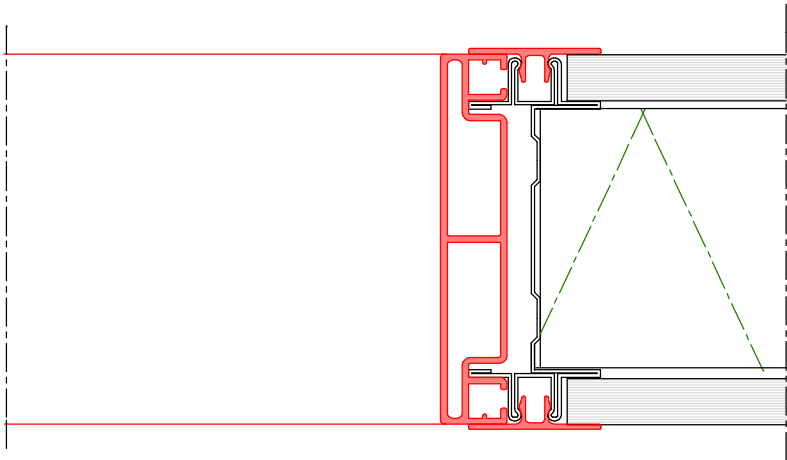

detail B

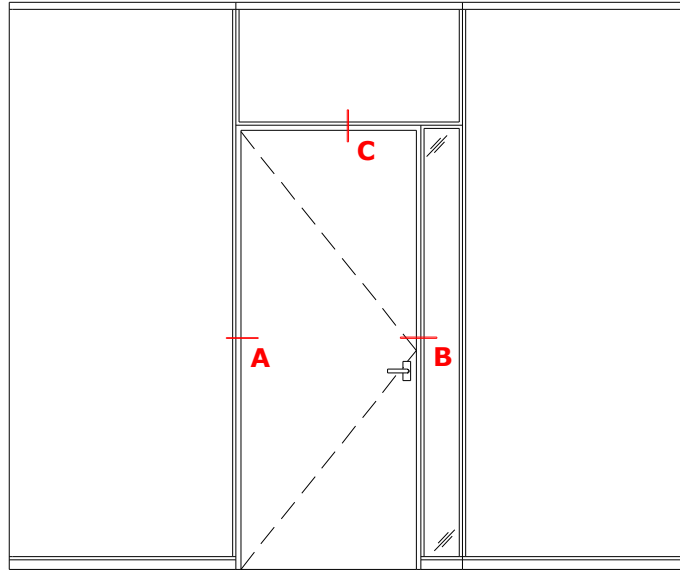

TecnoLine : moduul DAA

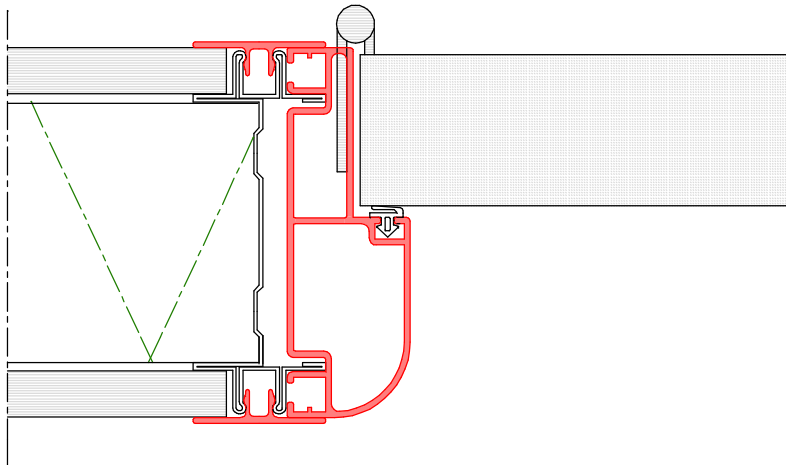

detail A

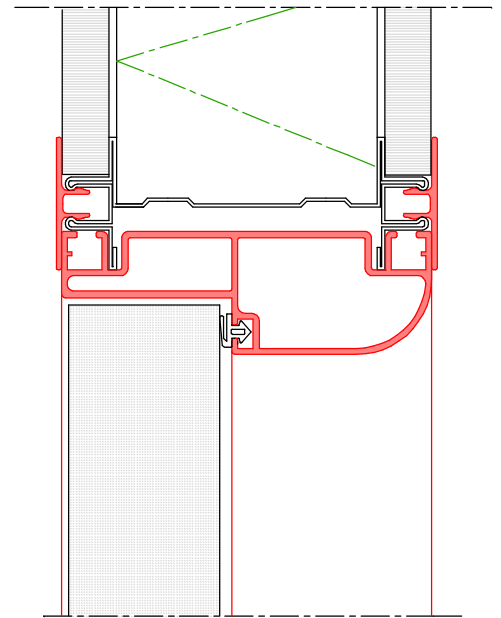

detail C

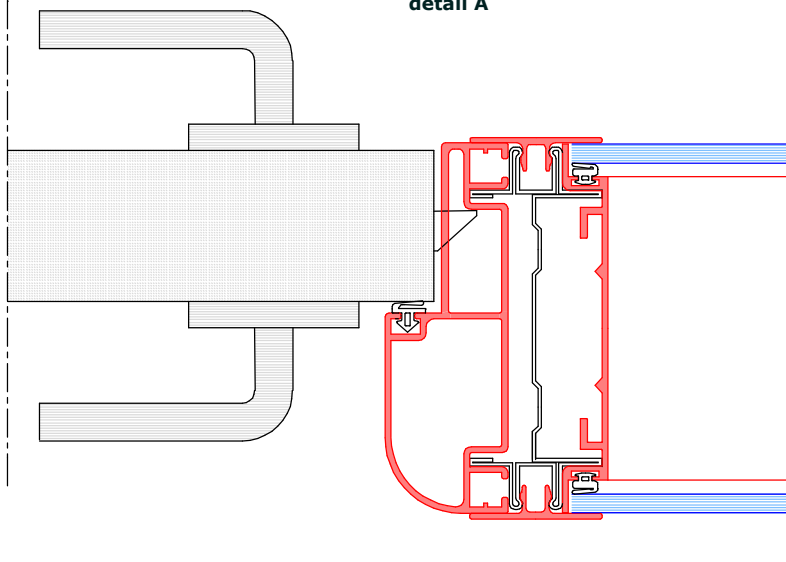

detail B

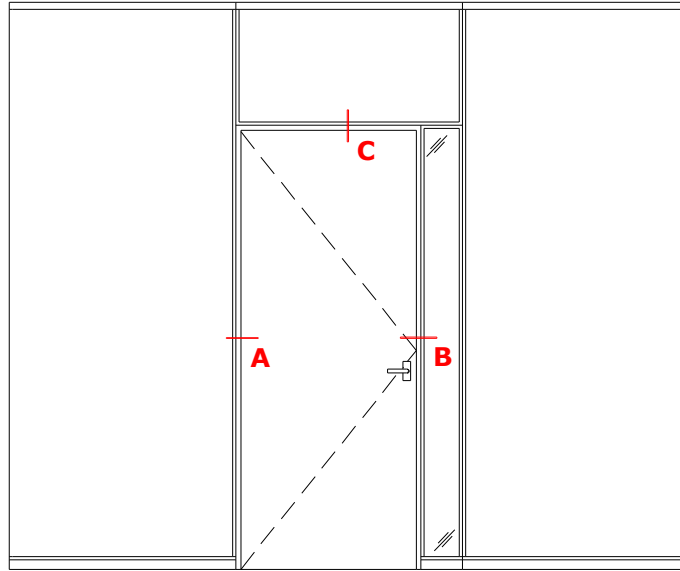

TecnoLine : moduul DAA

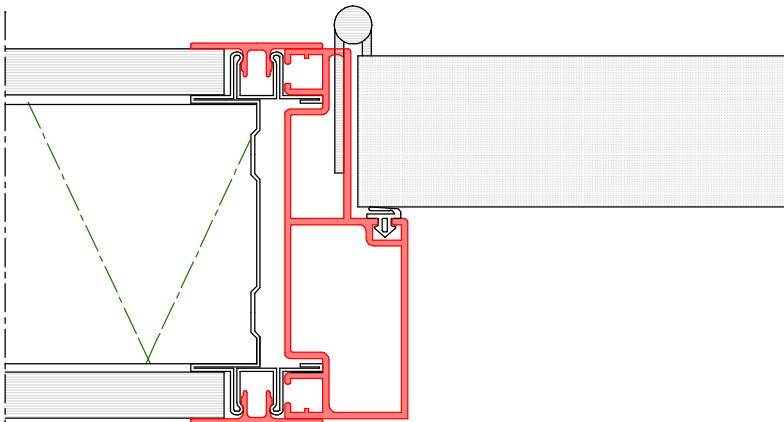

detail A

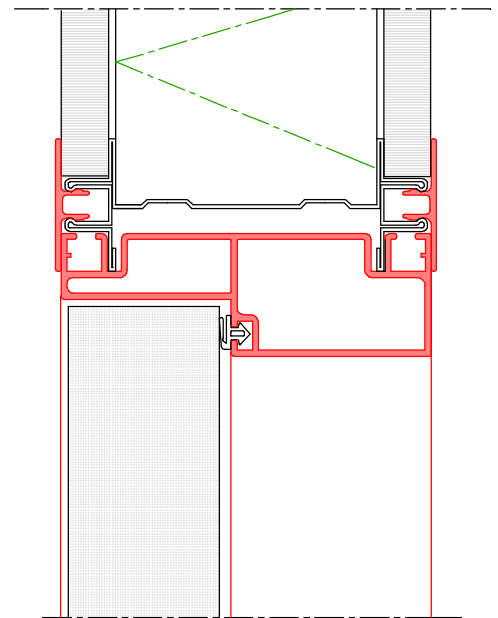

detail C

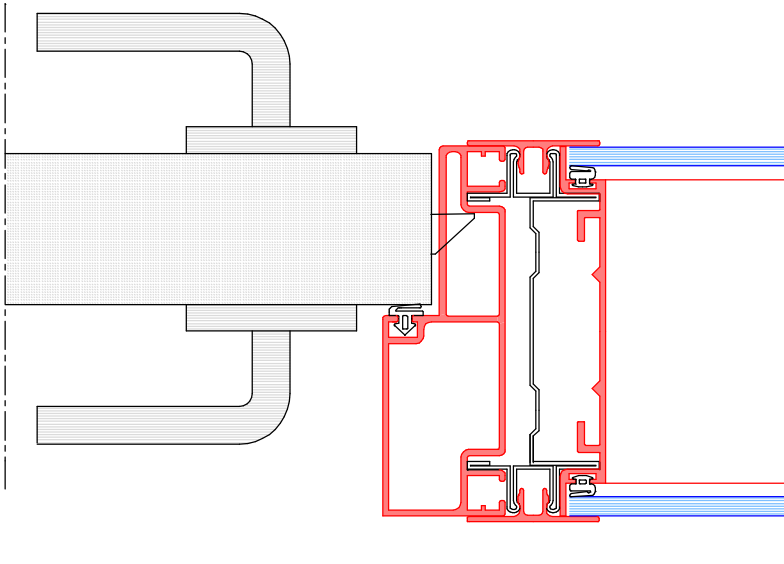

detail B

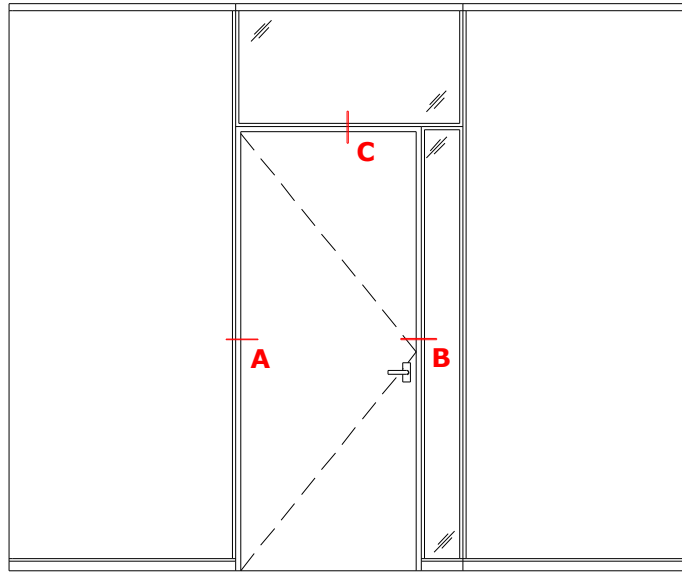

TecnoLine : moduul DBB

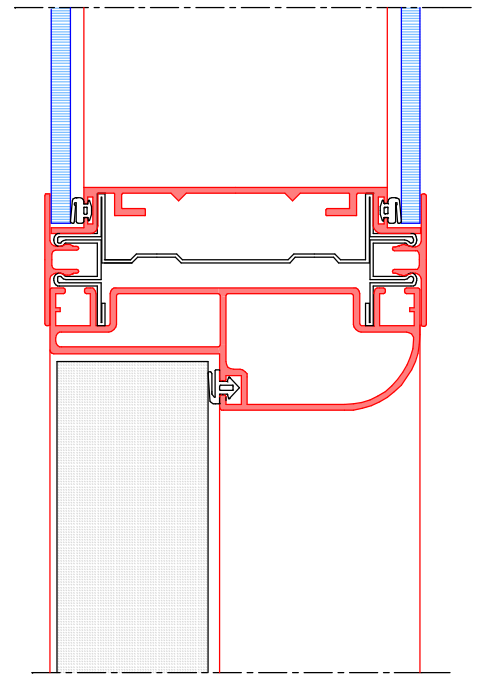
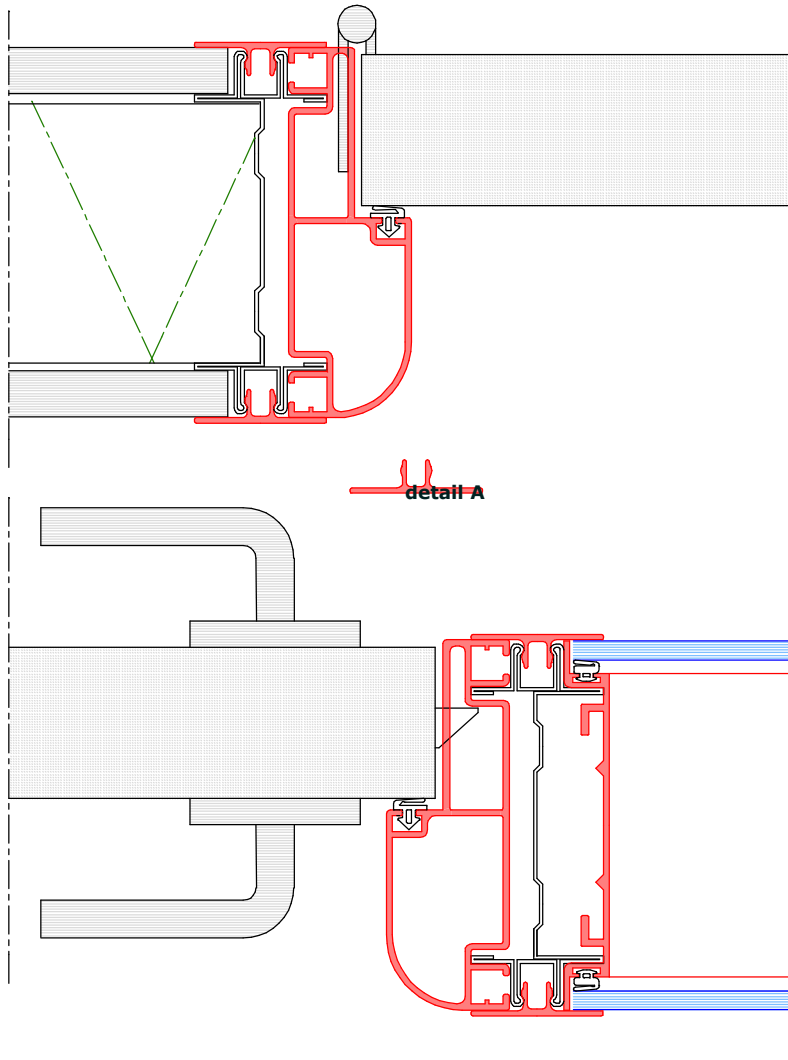

detail B

detail C

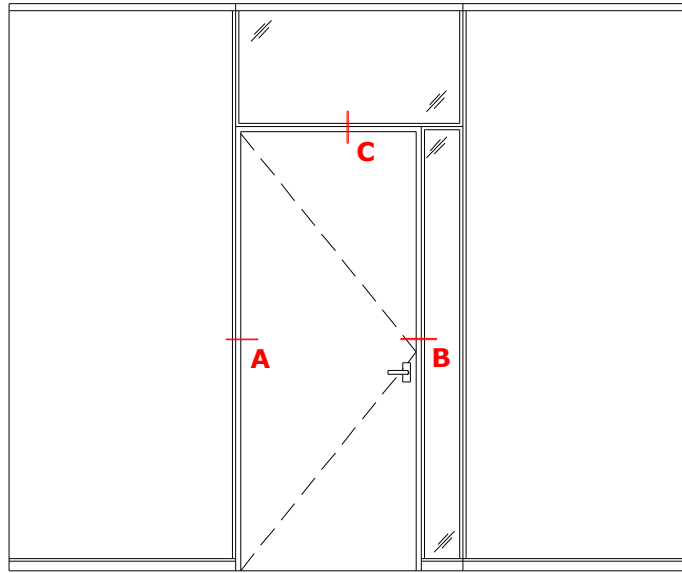

TecnoLine : moduul DBB

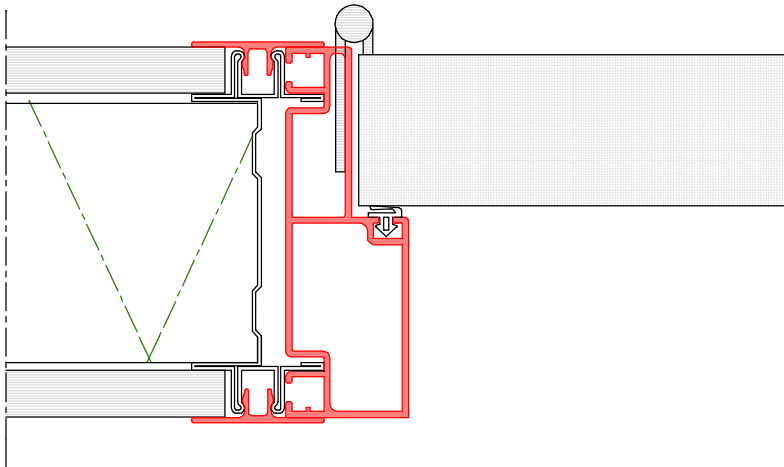

detail A

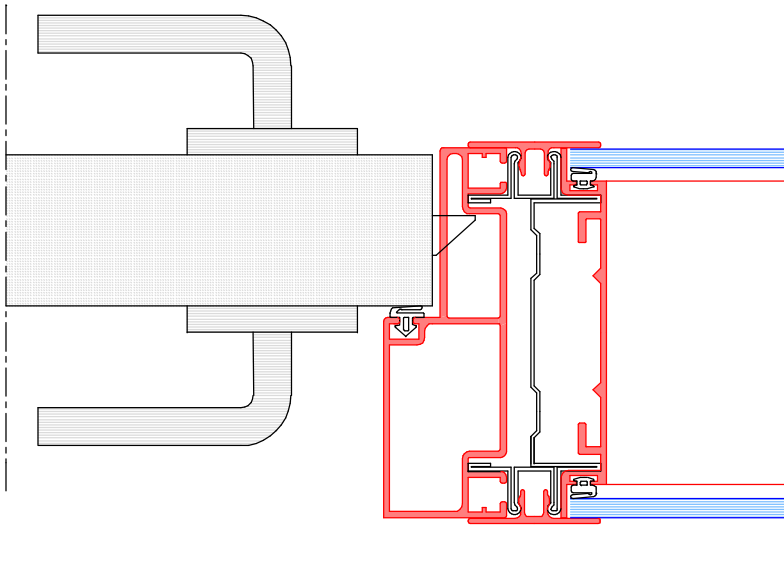

detail B

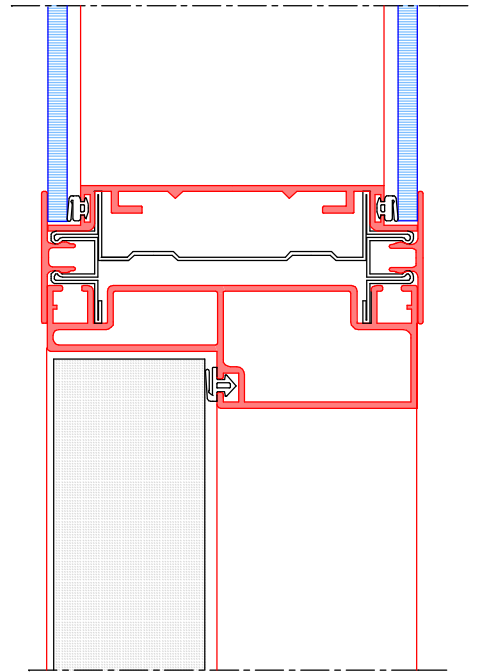

detail C

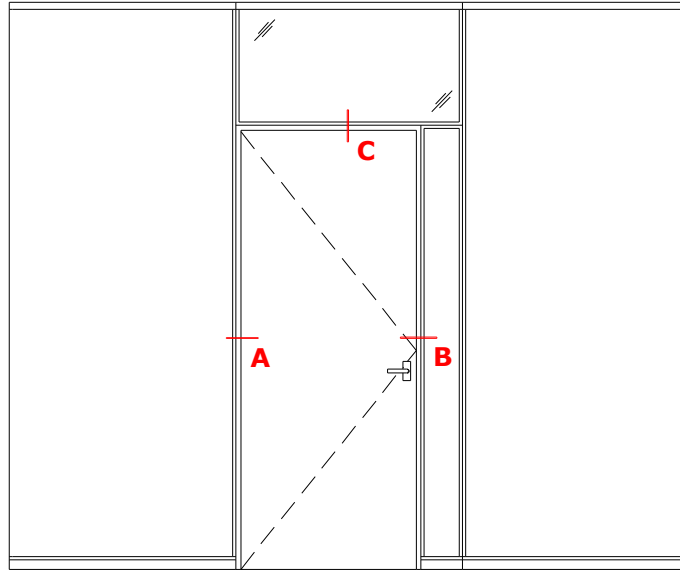

TecnoLine : moduul DCC

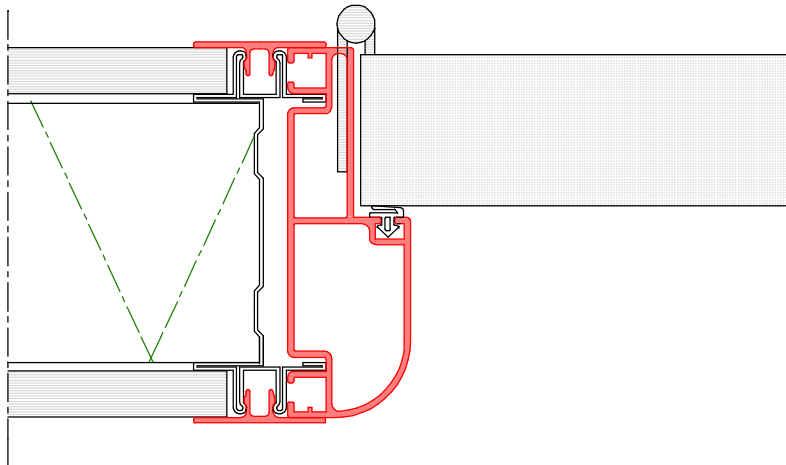

detail A

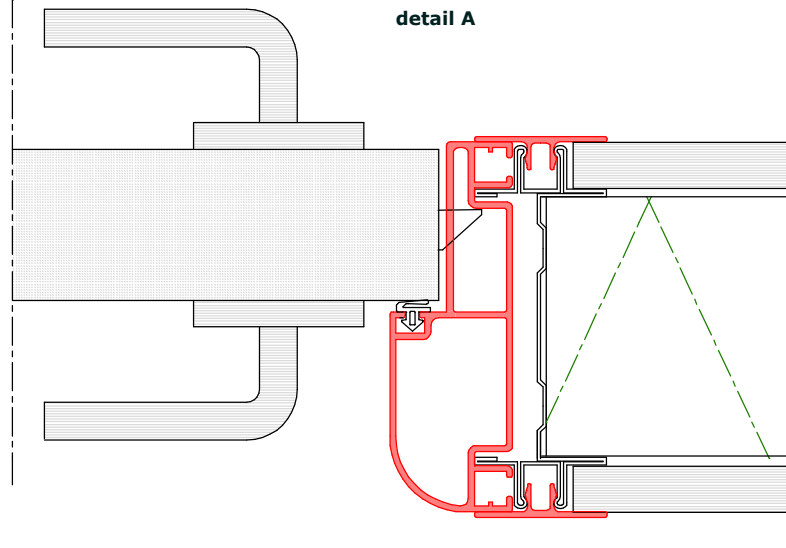

detail B

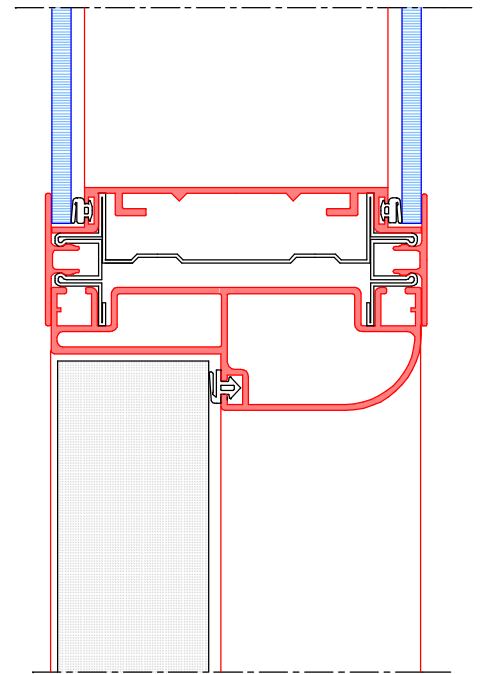

detail C

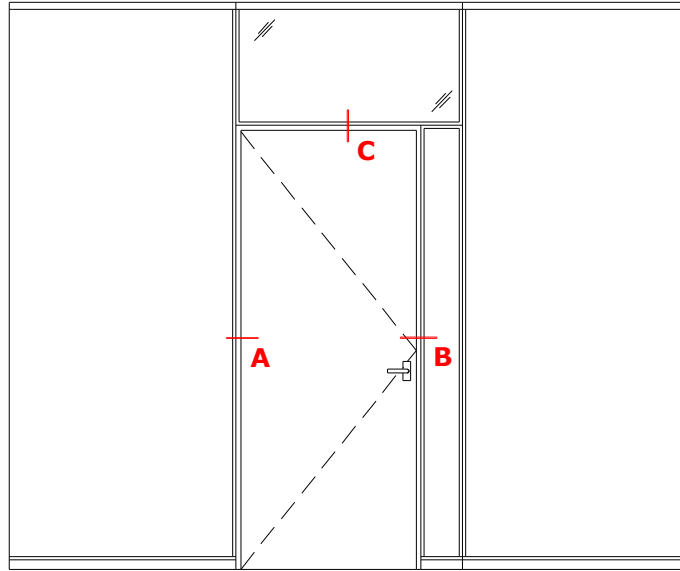

TecnoLine : moduul DCC

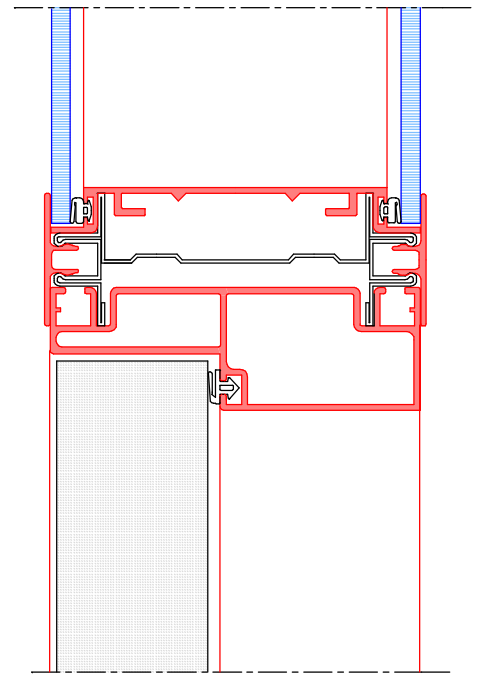
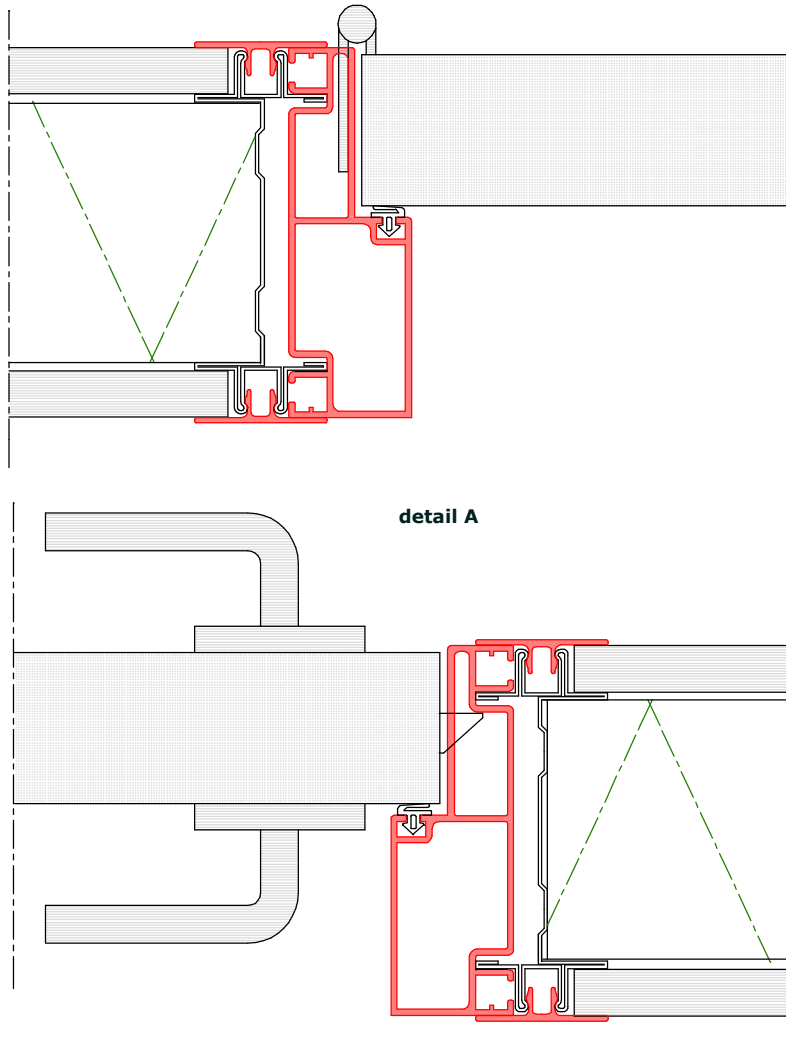

detail C

detail B

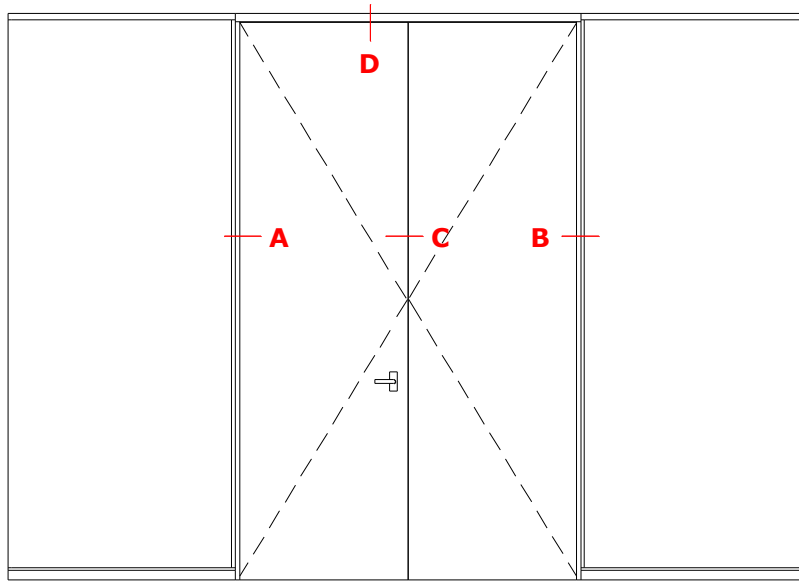

TecnoLine : moduul DDAW

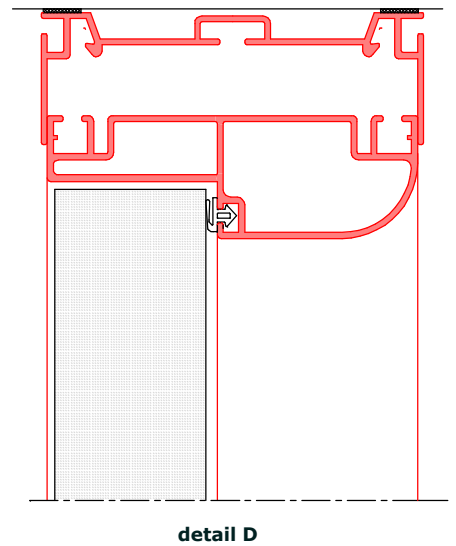
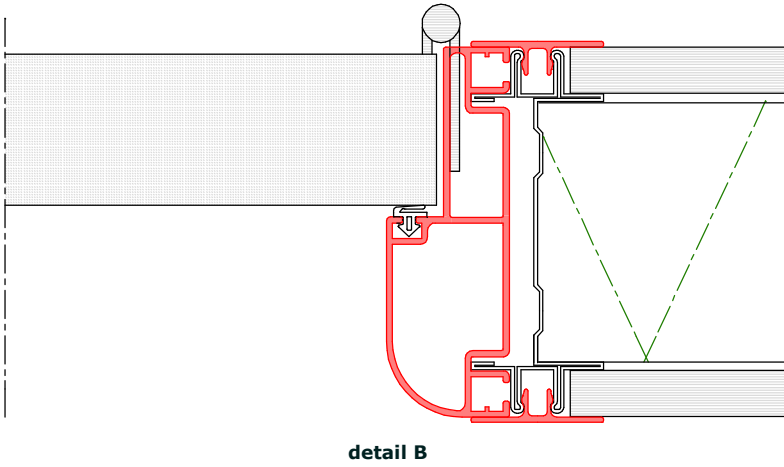
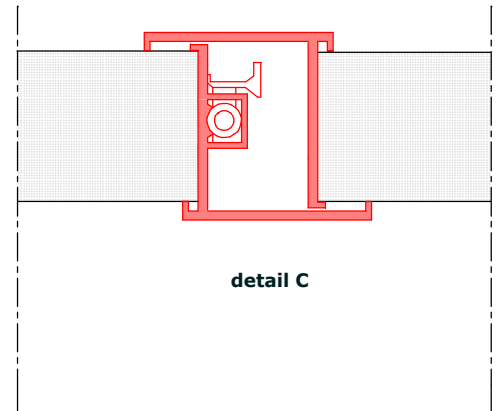
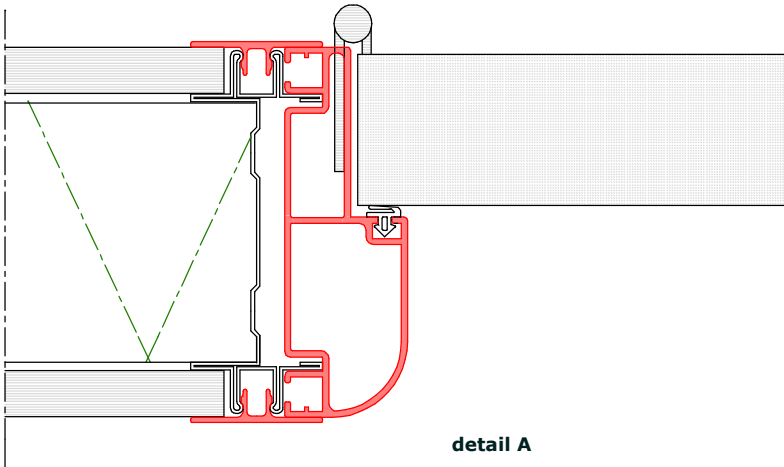

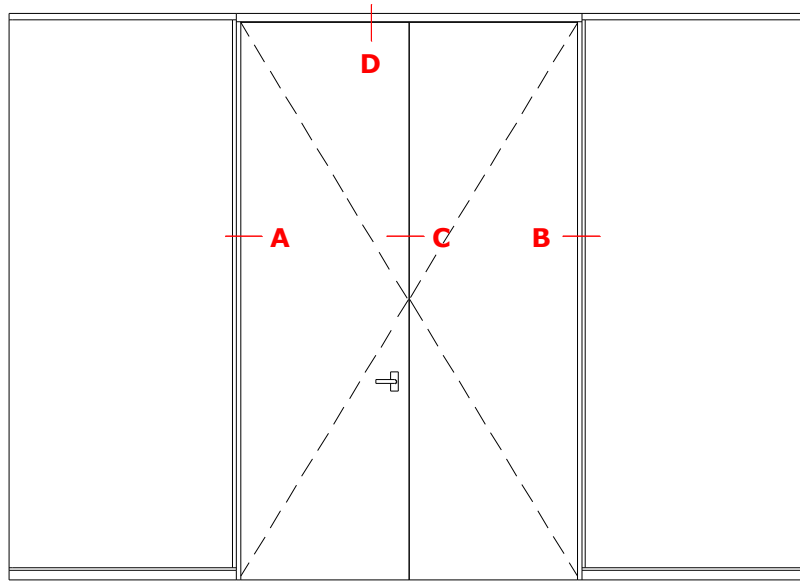

TecnoLine : moduul DDAW

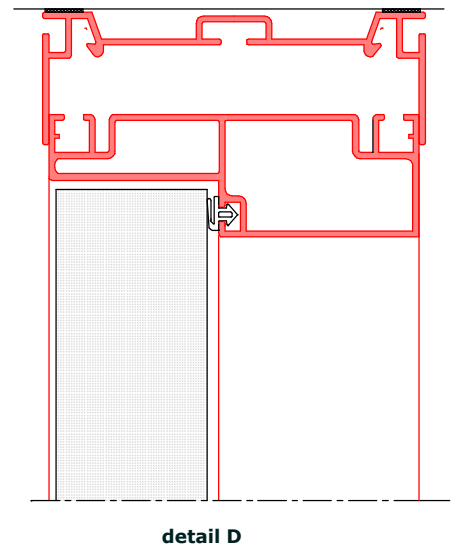
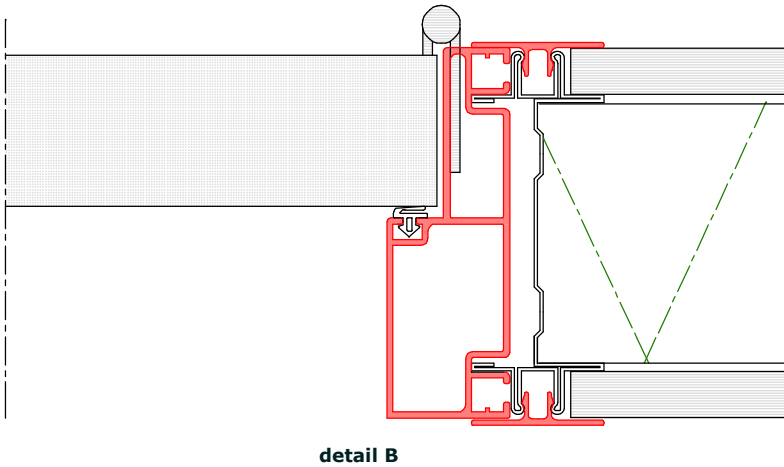
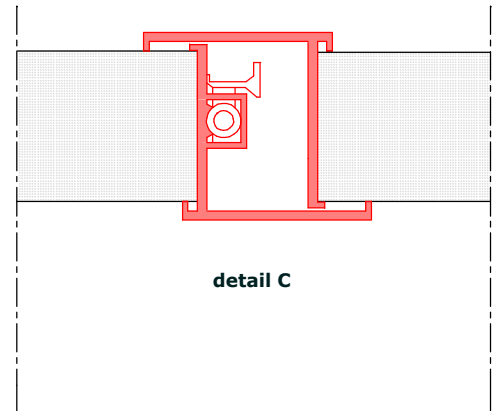
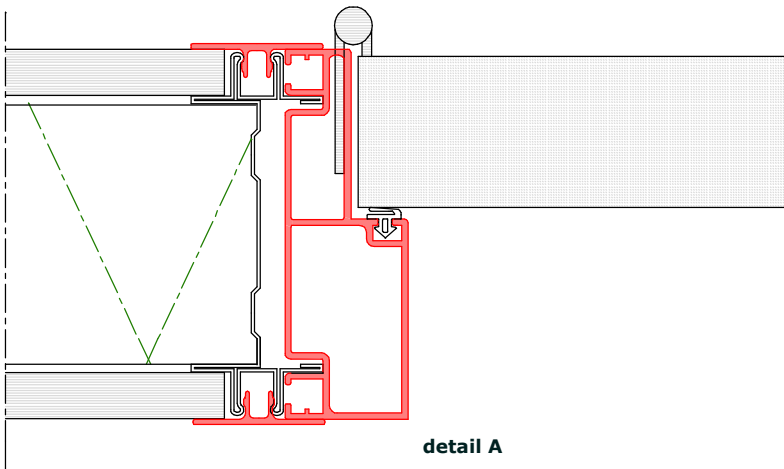

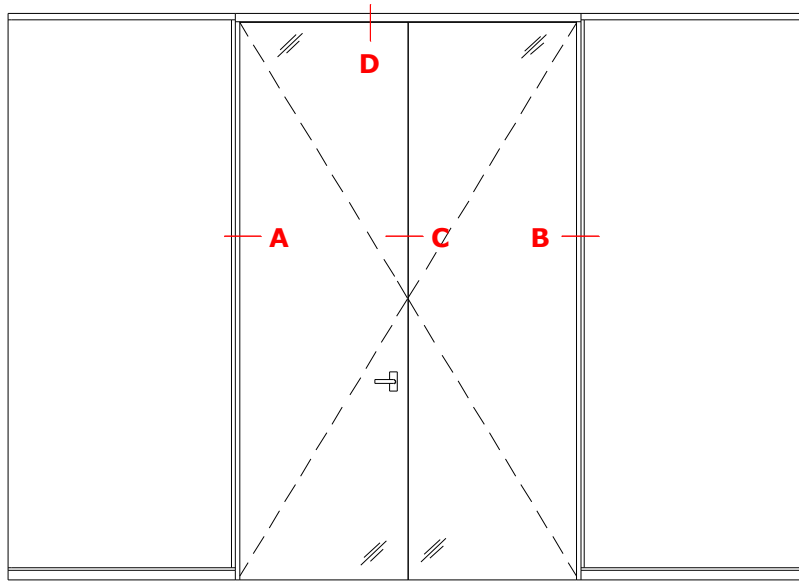

TecnoLine : moduul DDAW-HG

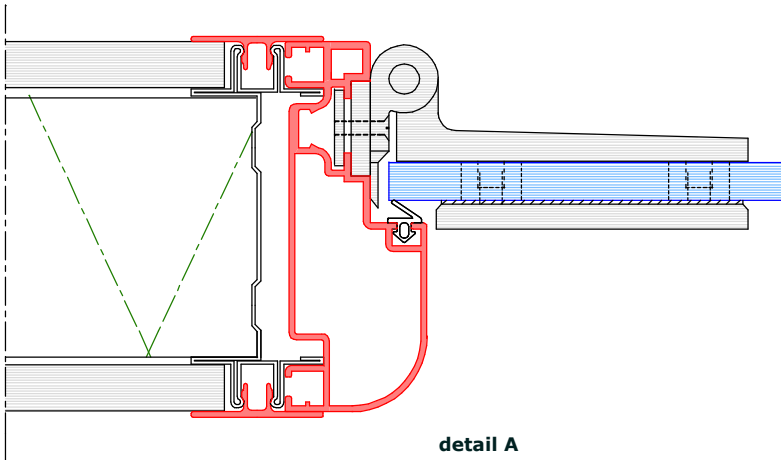

detail A

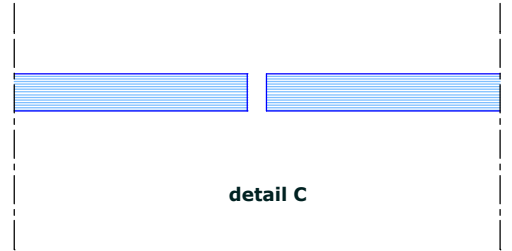

detail C

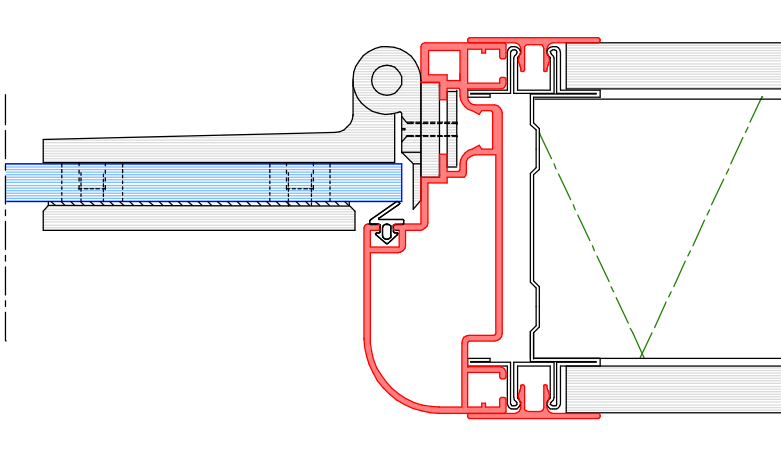

detail B

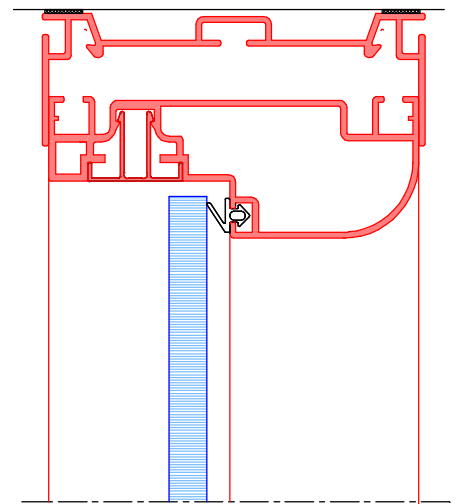

detail D

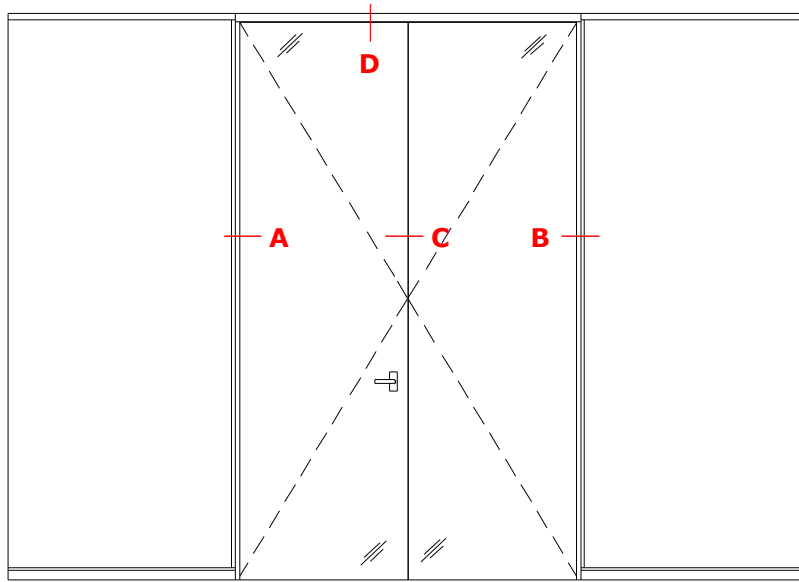

TecnoLine : moduul DDAW-HG

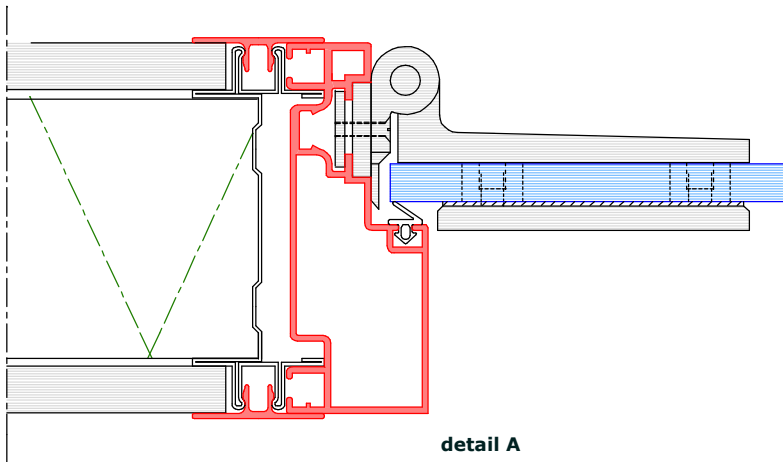

detail A

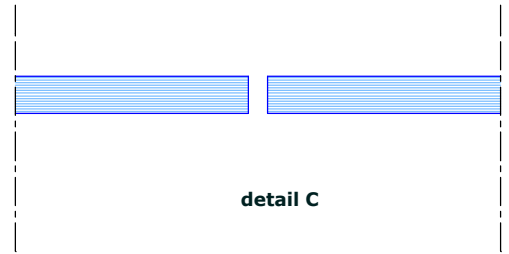

detail C

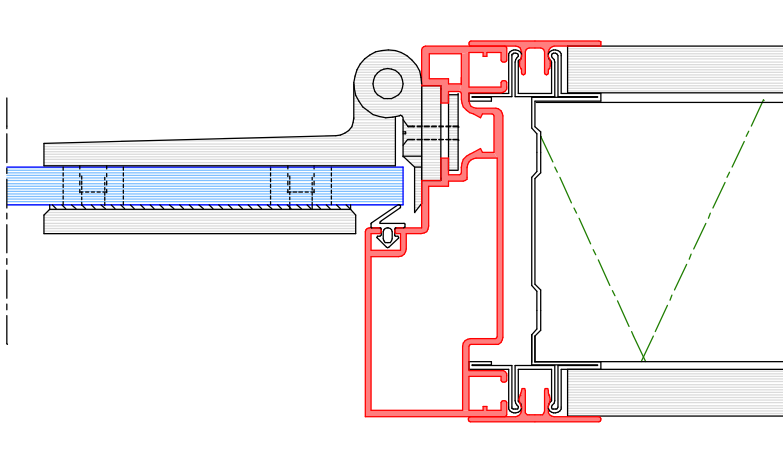

detail B

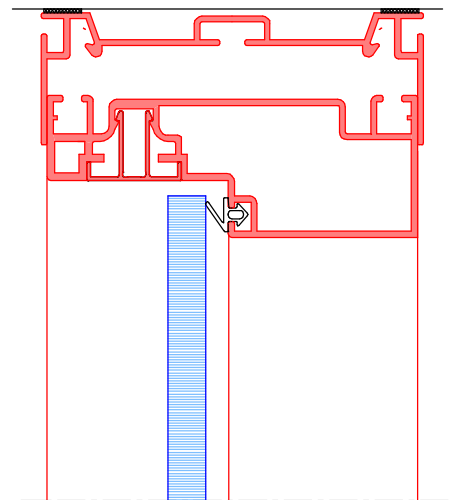

detail D

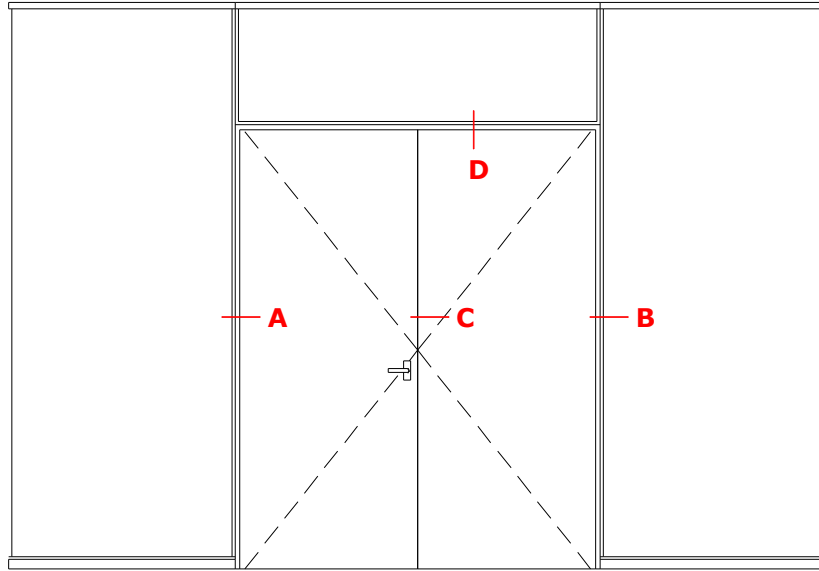

TecnoLine : moduul DME

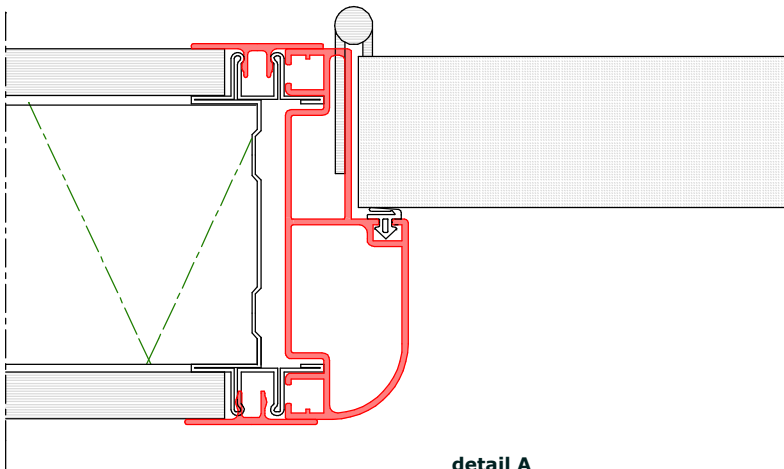

detail A

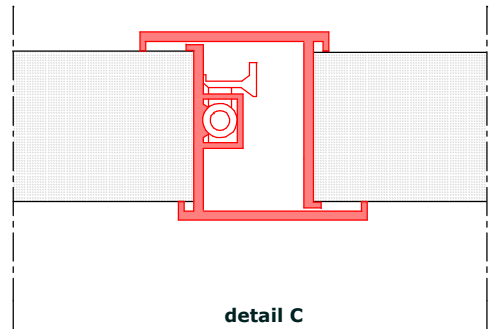

detail C

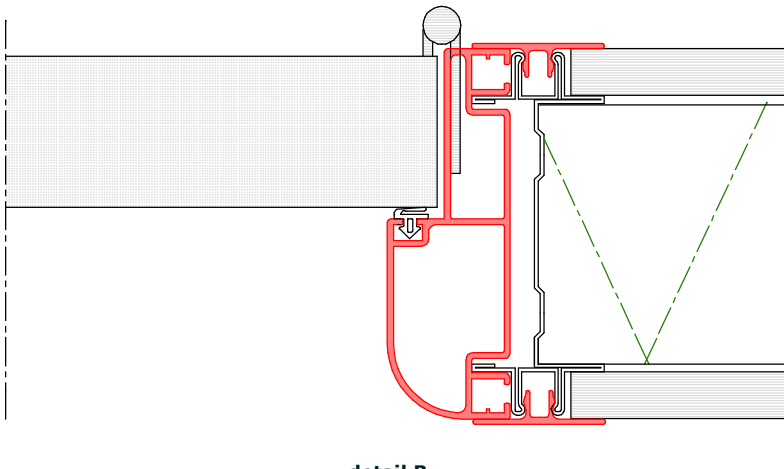

detail B

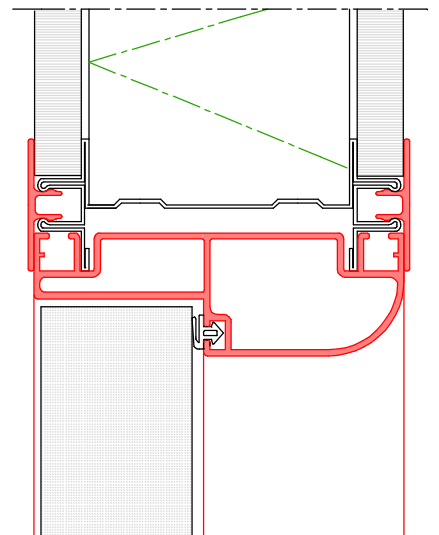

detail D

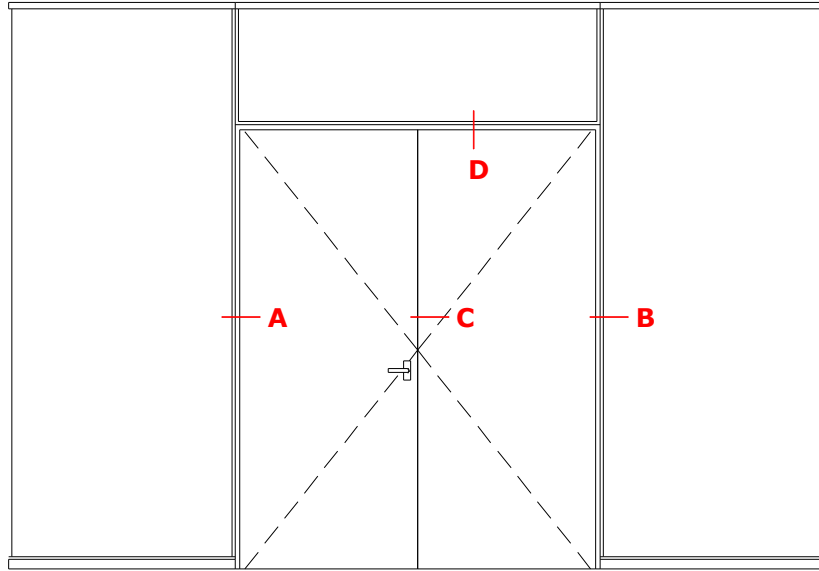

TecnoLine : moduul DME

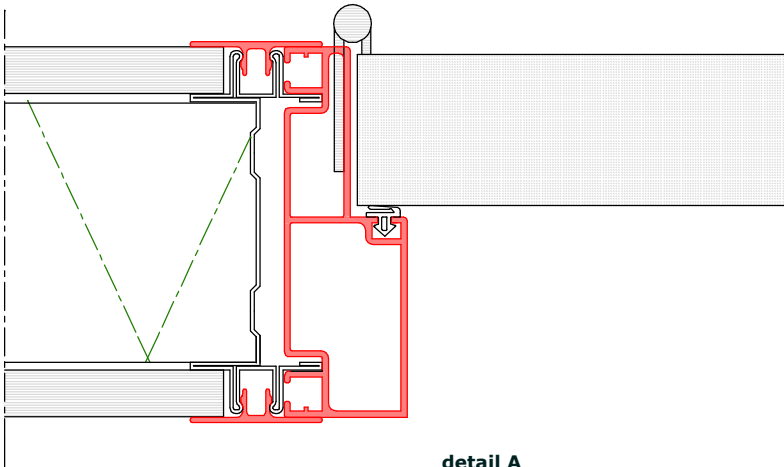

detail A

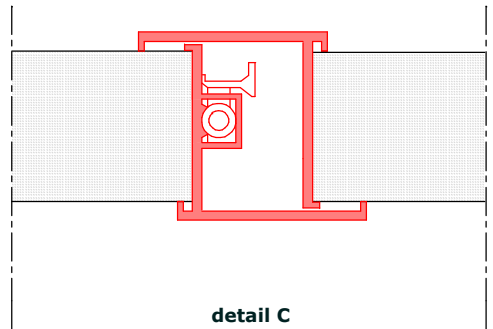

detail C

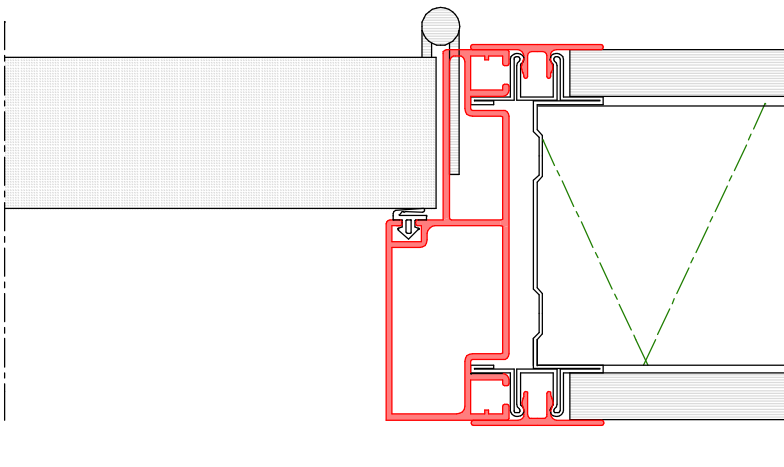

detail B

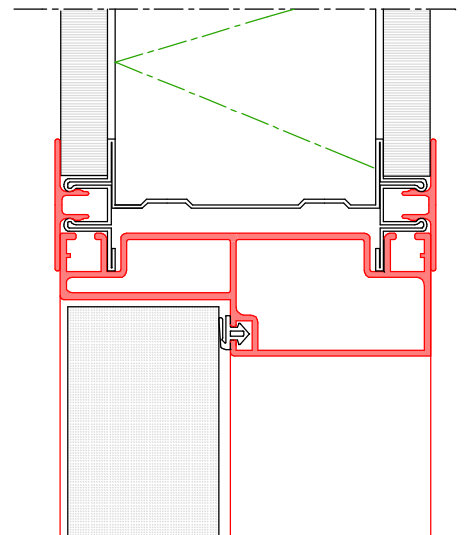

detail D

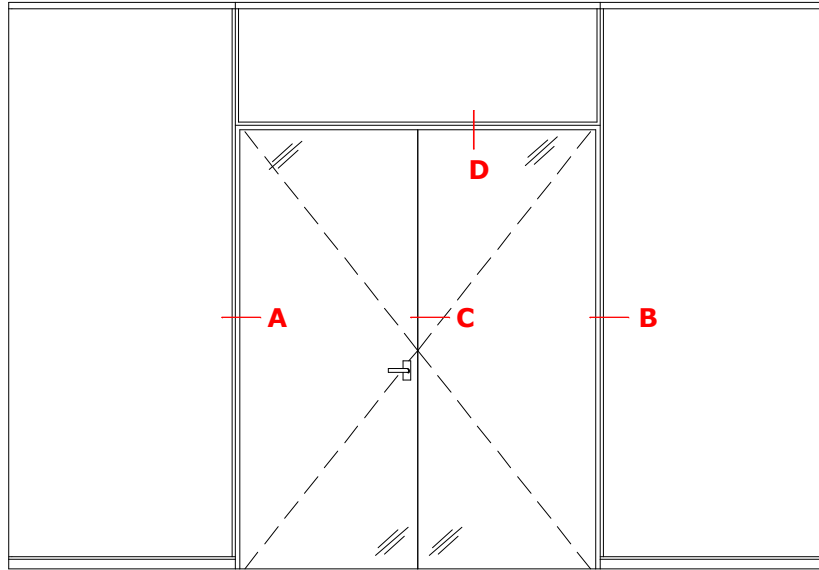

TecnoLine : moduul DME-HG

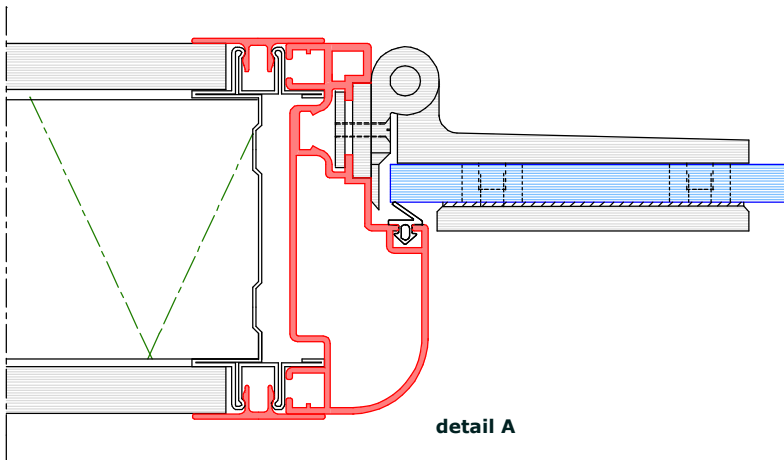

detail A

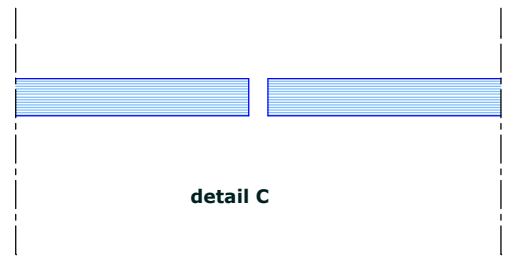

detail C

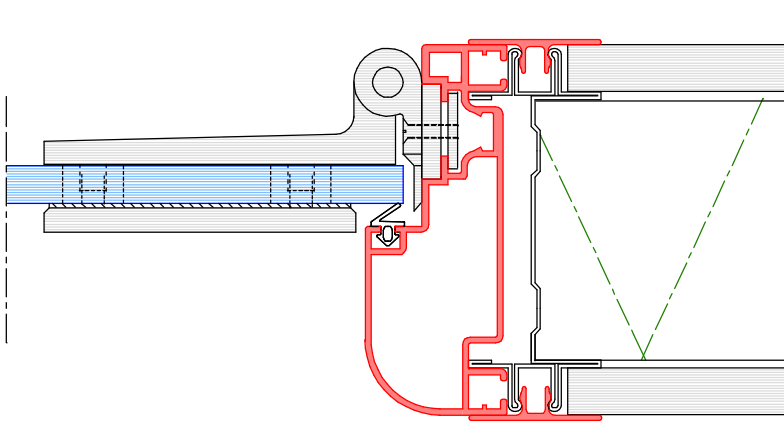

detail B

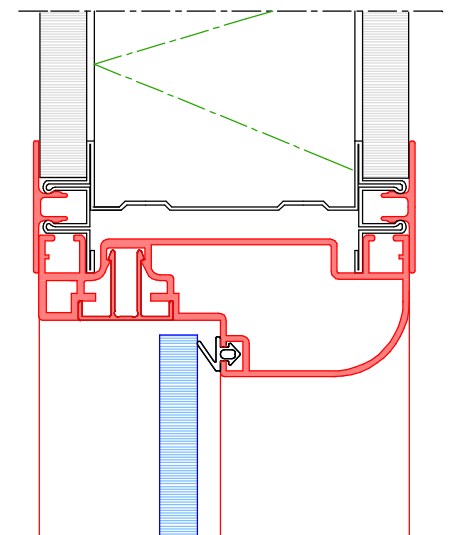

detail D

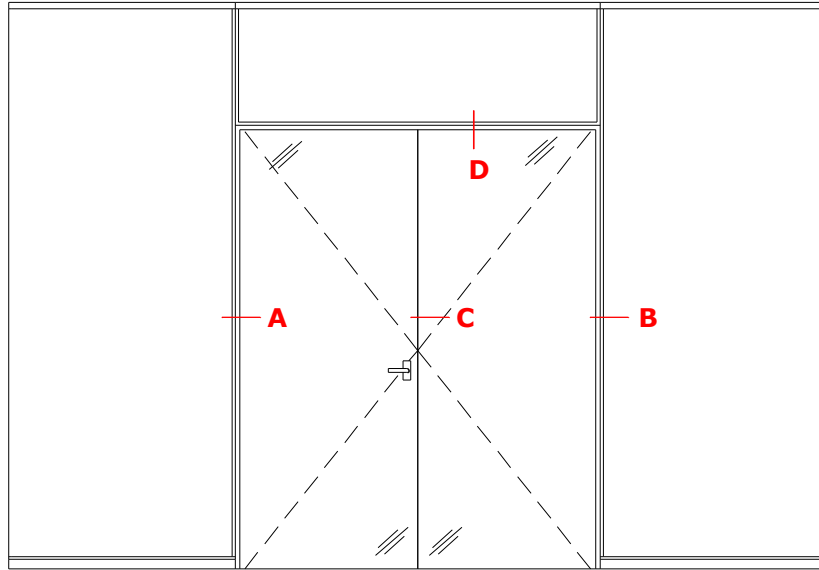

TecnoLine : moduul DME-HG

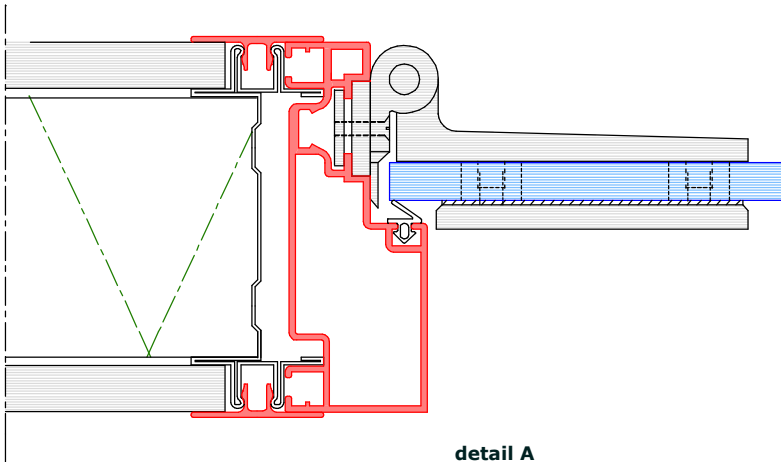

detail A

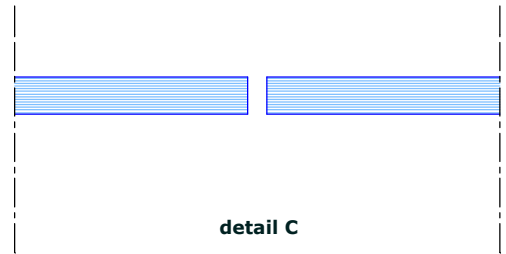

detail C

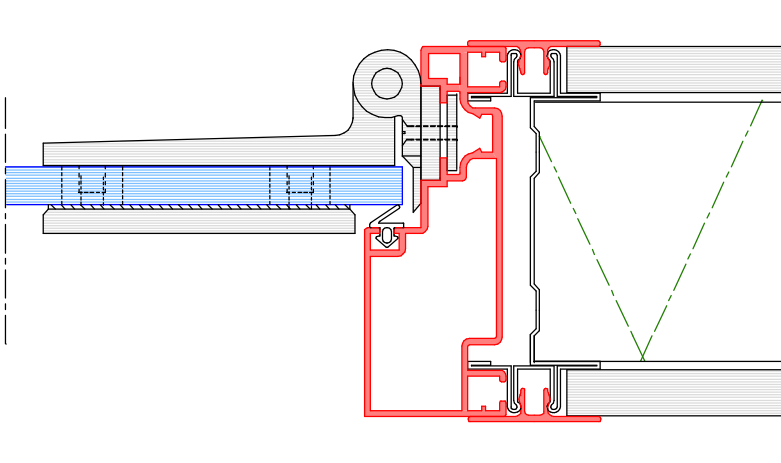

detail B

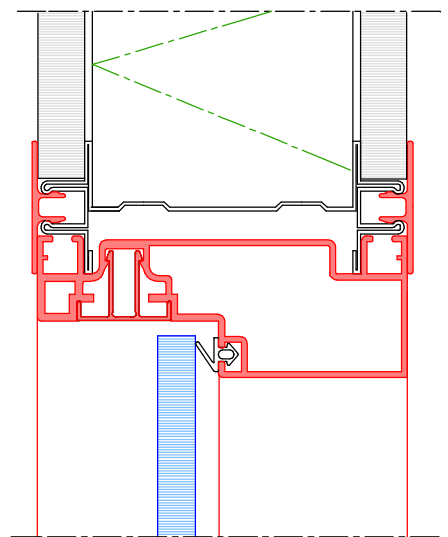

detail D

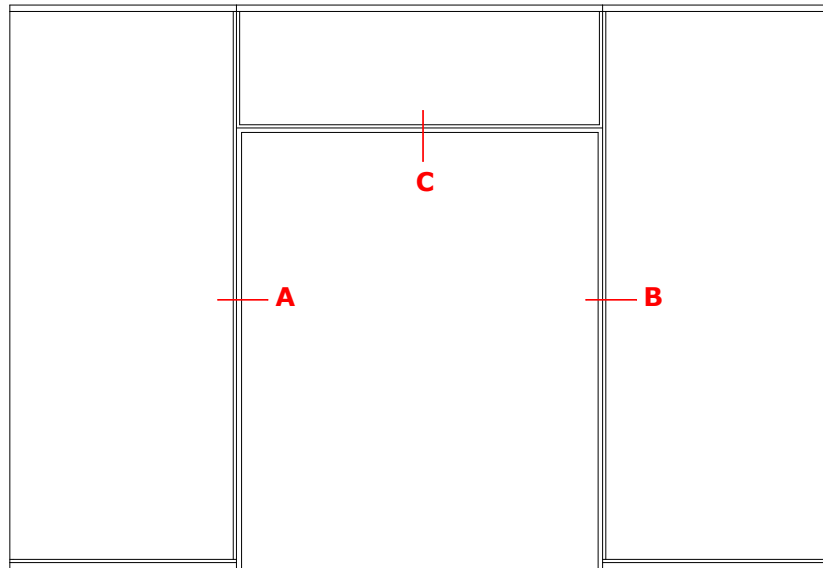

TecnoLine : moduul DME-DL

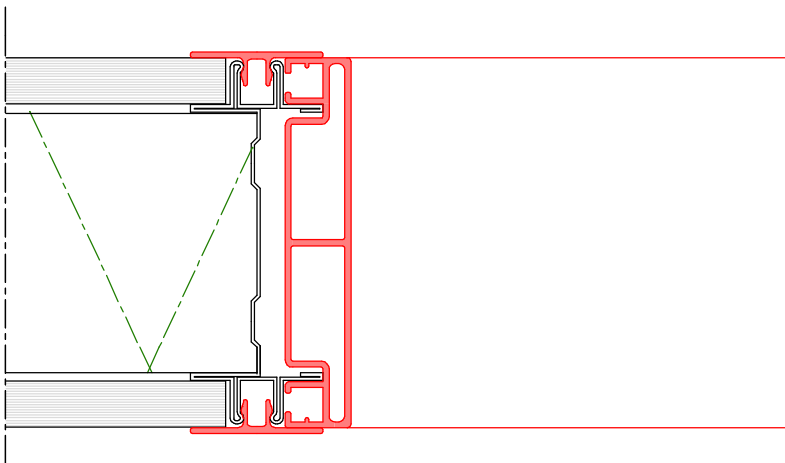

detail A

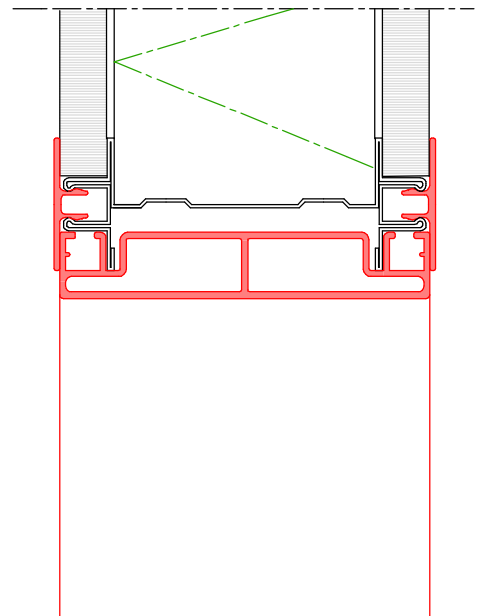
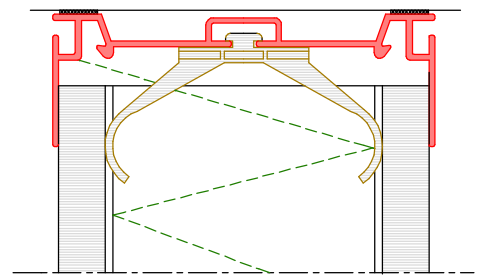

detail B

detail C

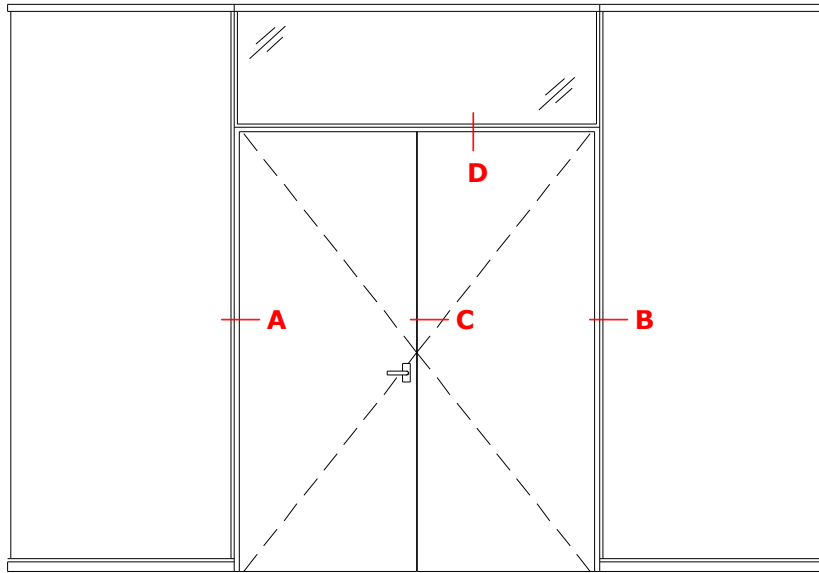

TecnoLine : moduul DDH

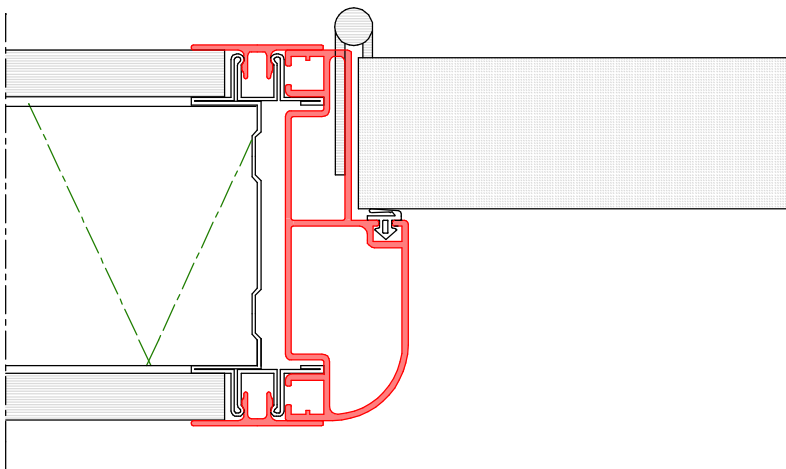

detail A

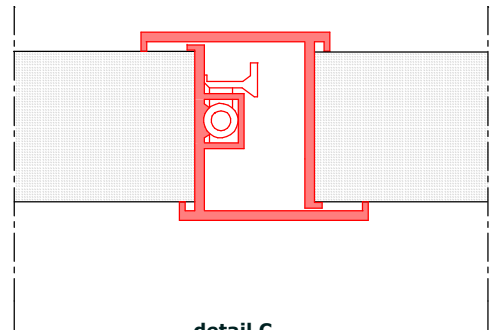

detail C

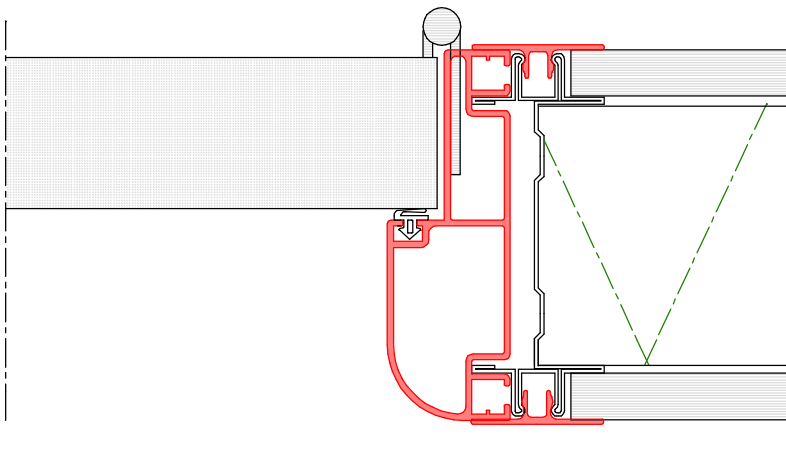

detail B

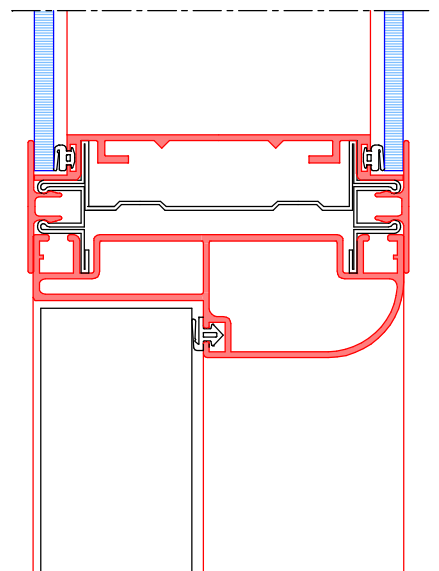

detail D

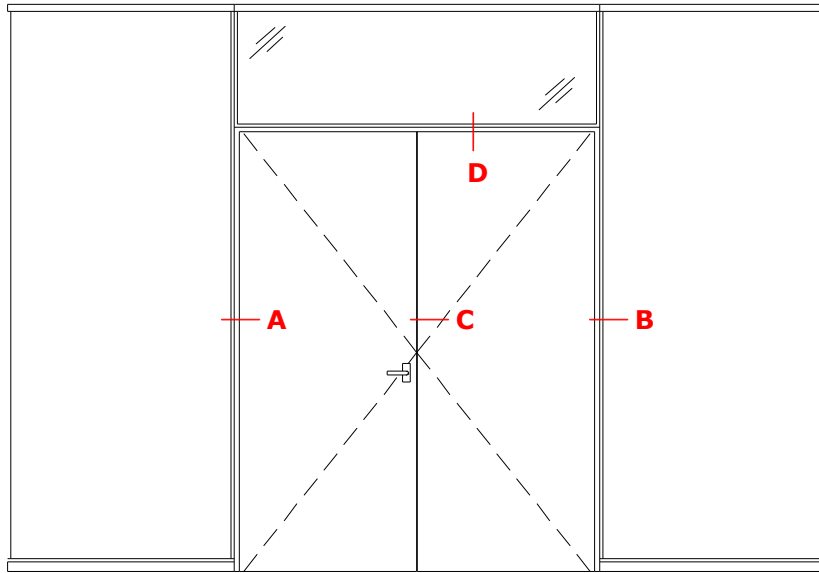

TecnoLine : moduul DDH

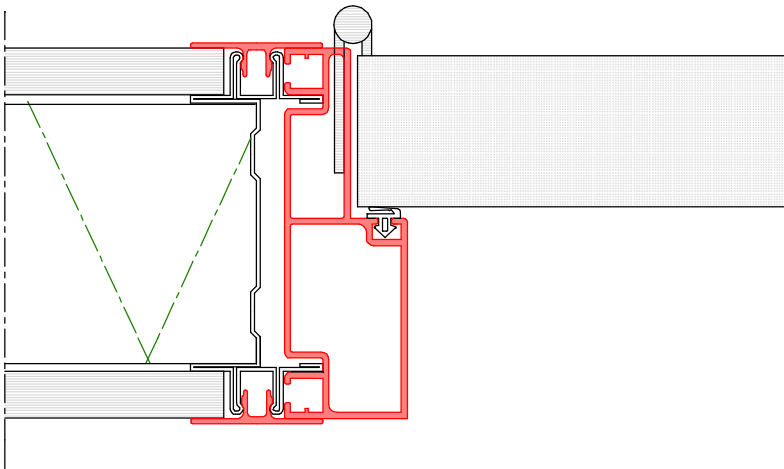

detail A

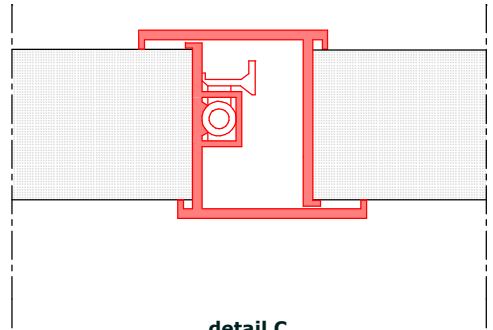

detail C

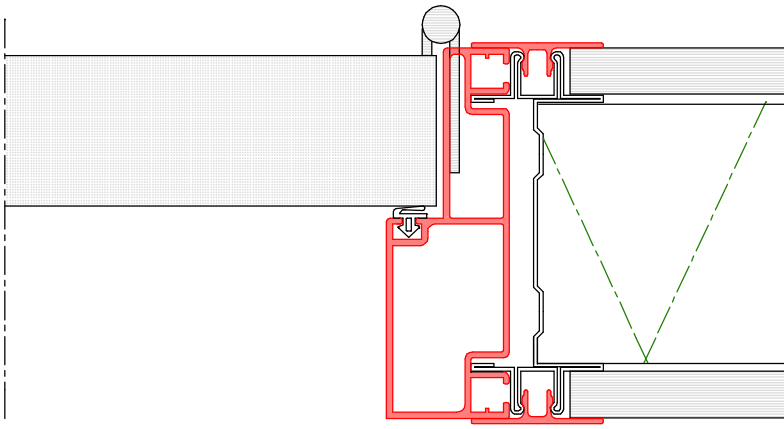

detail B

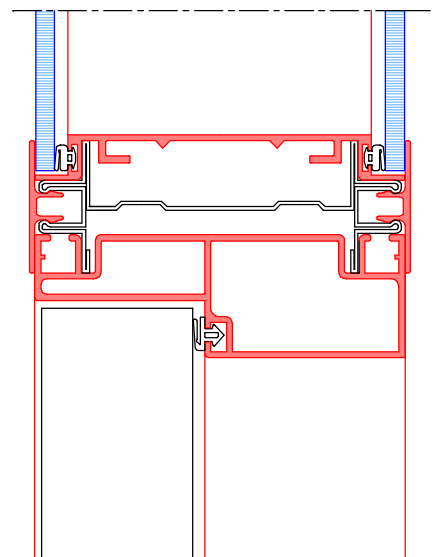

detail D

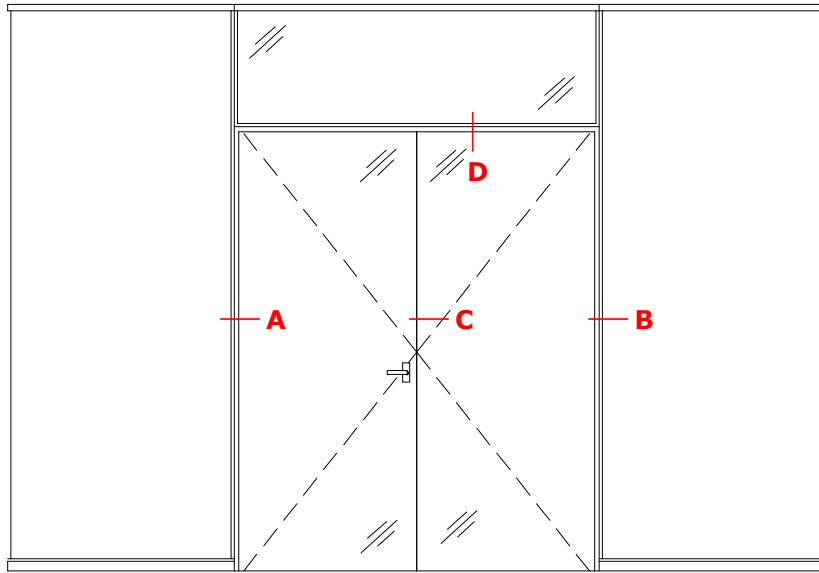

TecnoLine : moduul DDH-HG

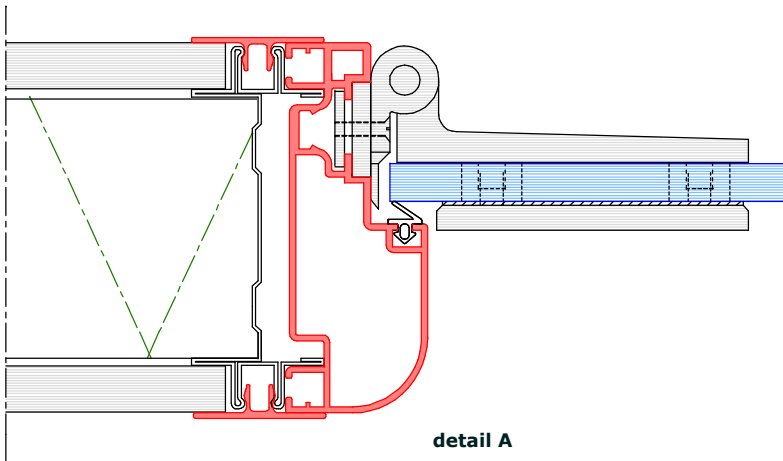

detail A

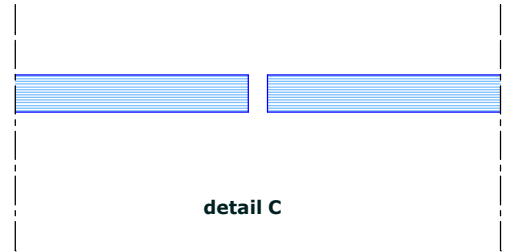

detail C

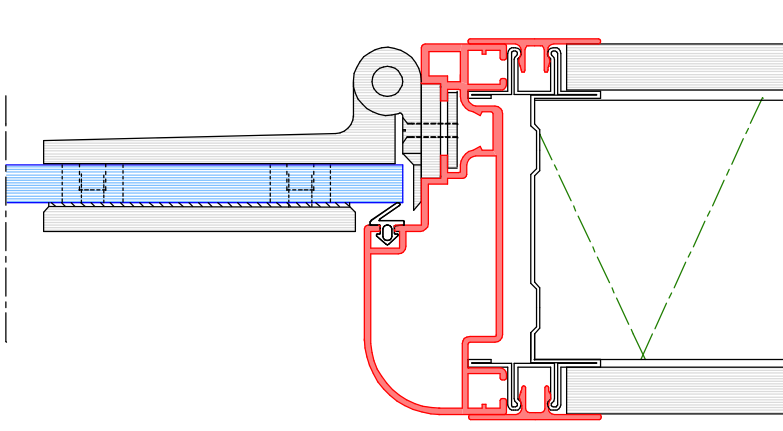

detail B

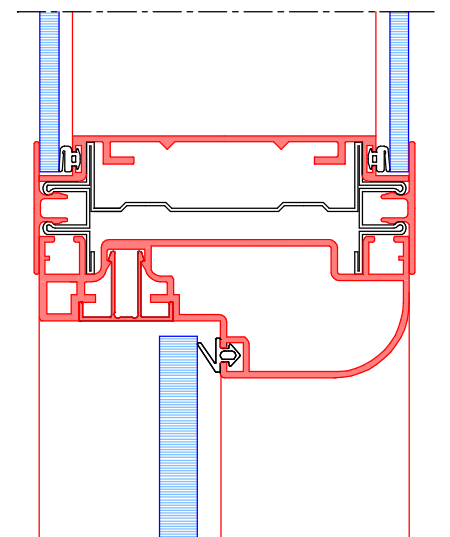

detail D

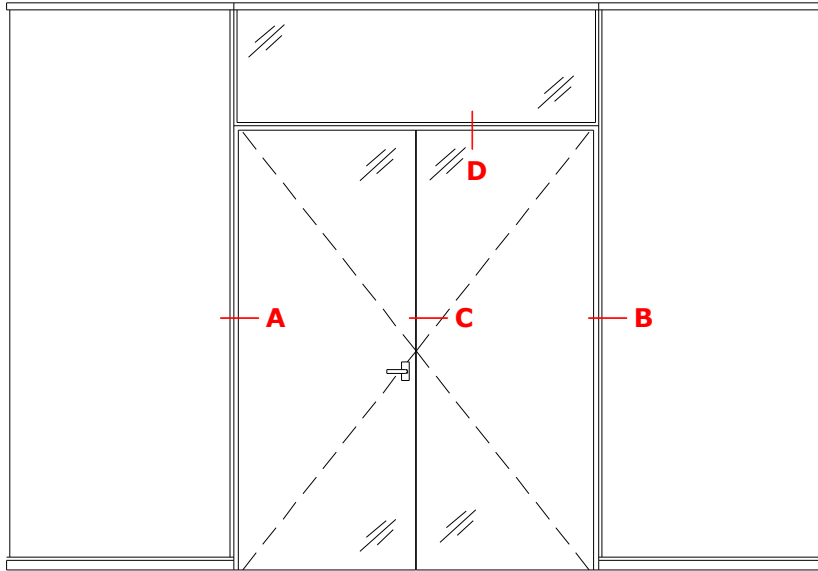

TecnoLine : moduul DDH-HG

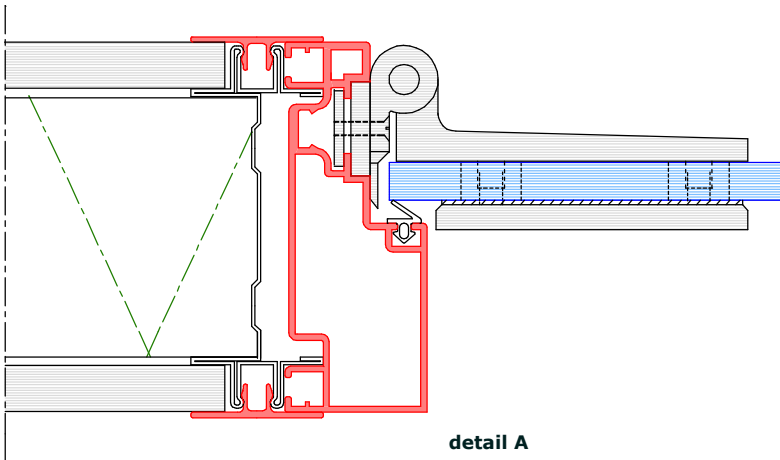

detail A

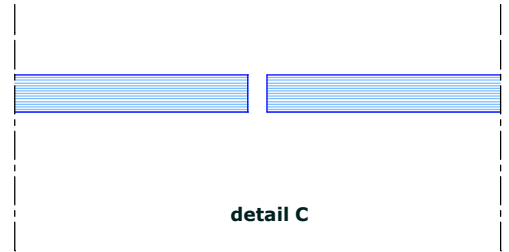

detail C

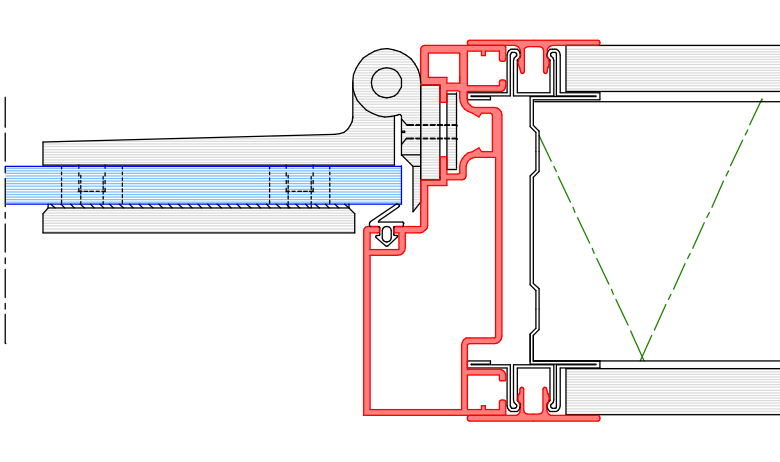

detail B

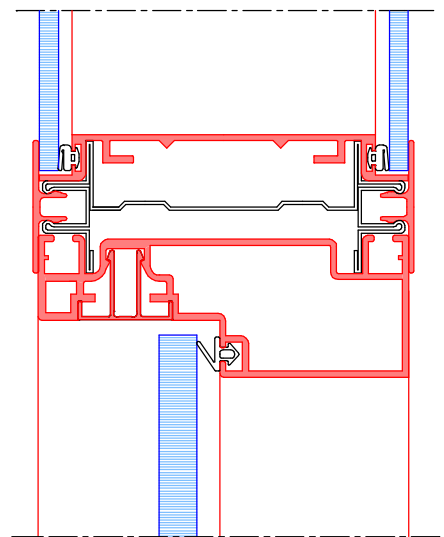

detail D

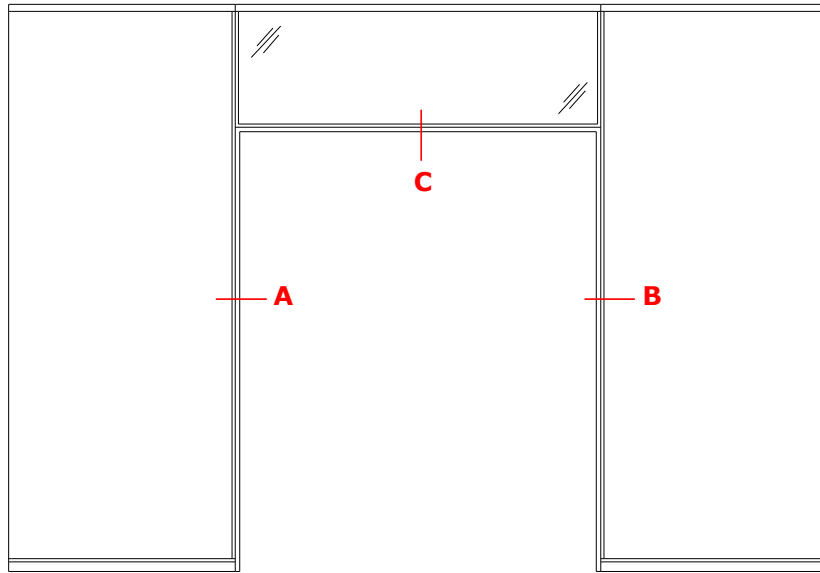

TecnoLine : moduul DDH-DL

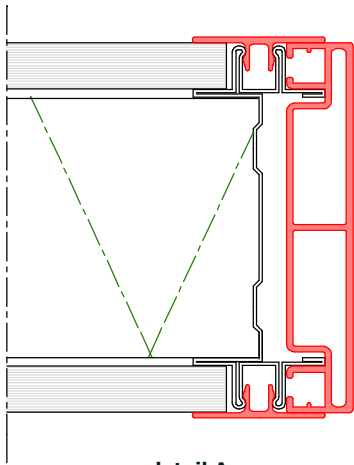

detail A

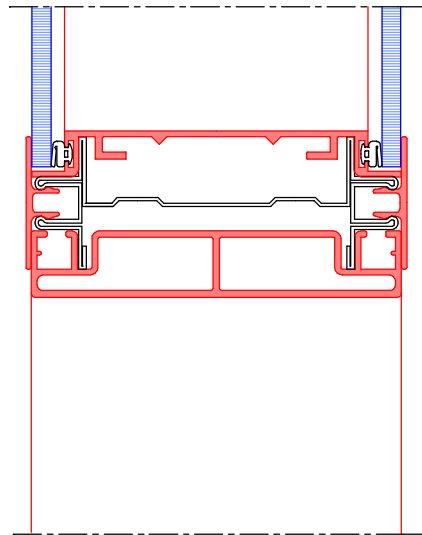

detail C

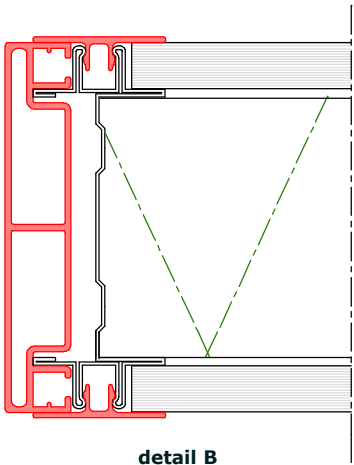

detail B

TecnoLine | hoekoplossingen | corner solutions | Ecklösungen

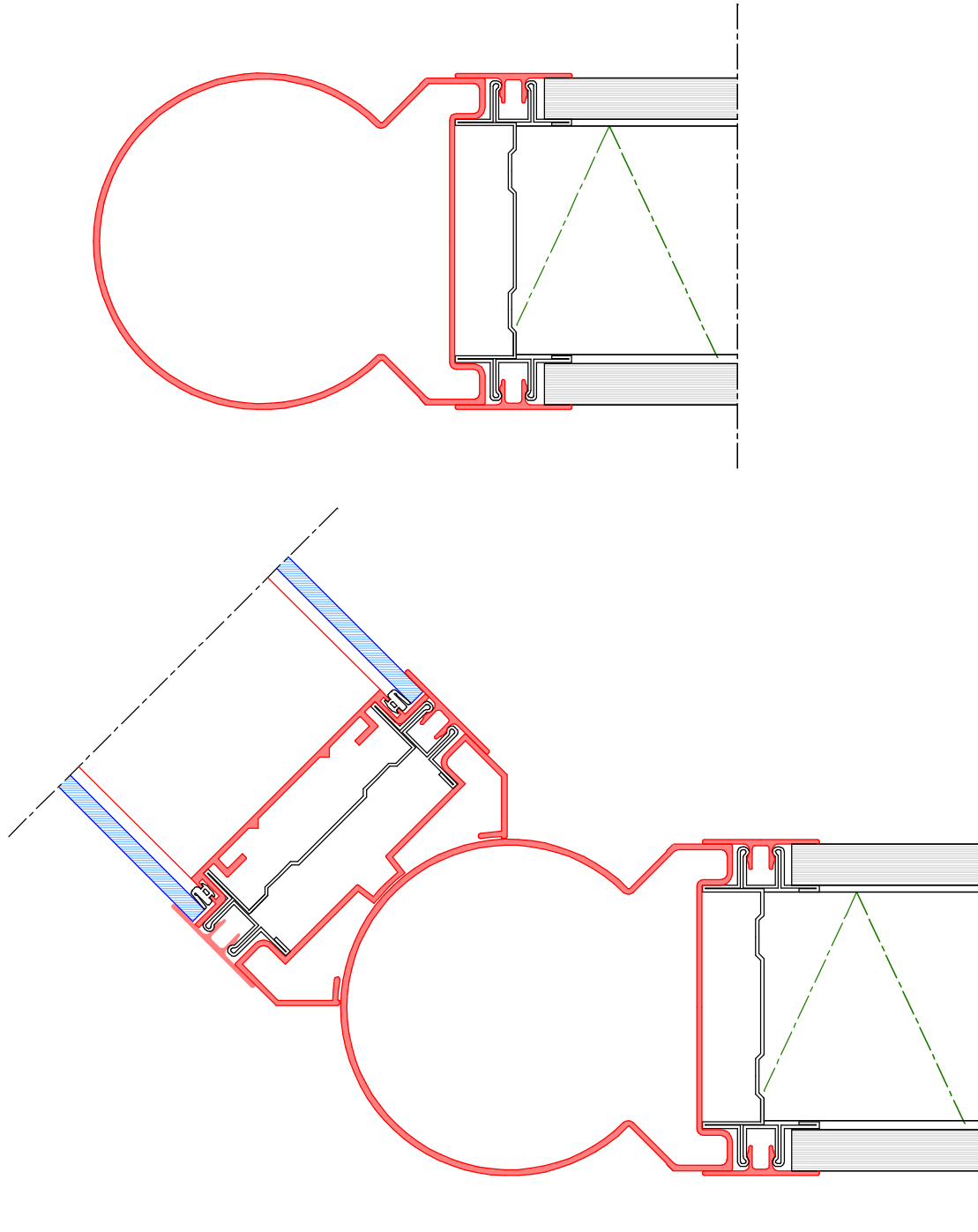

TecnoLine | hoekoplossingen | corner solutions | Ecklösungen

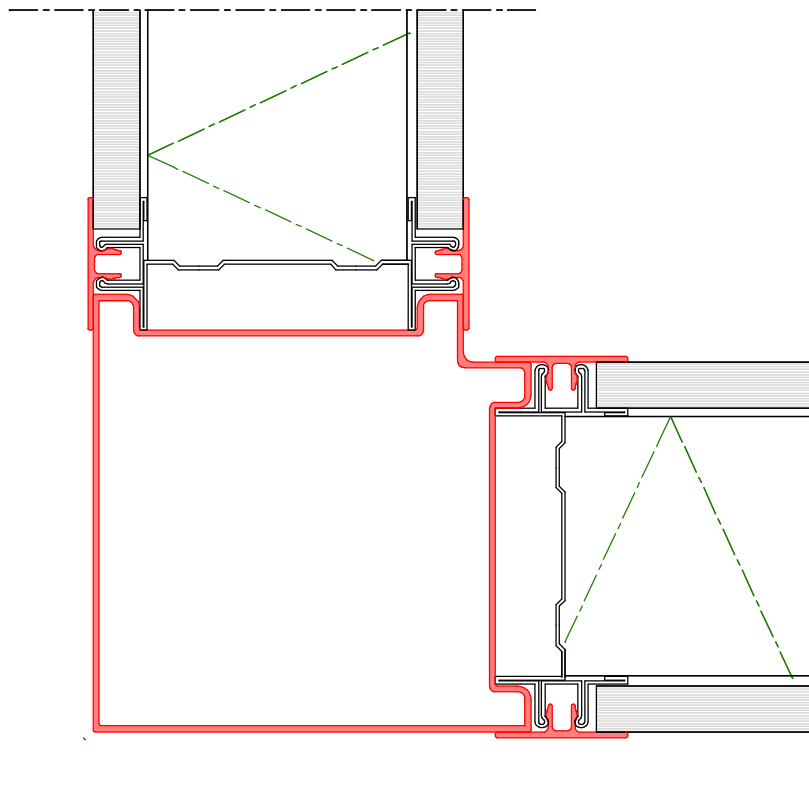
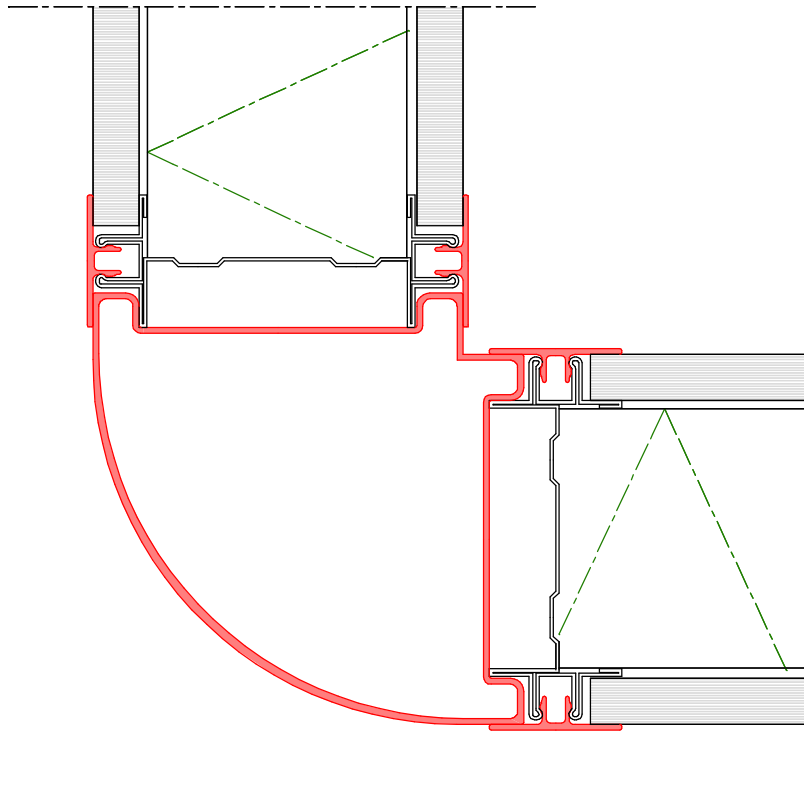

TecnoLine | hoekoplossingen | corner solutions | Ecklösungen

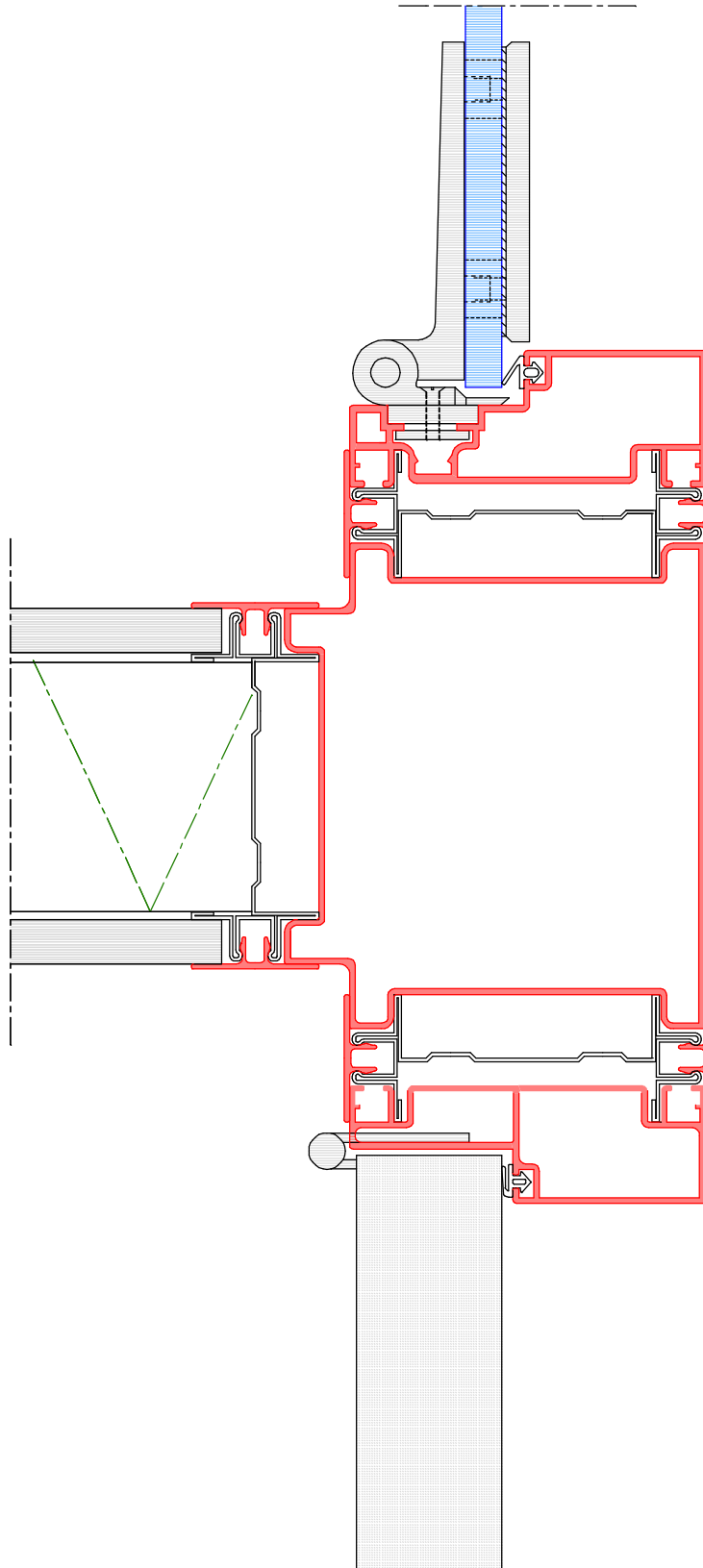

TecnoLine | hoekoplossingen | corner solutions | EckLösungen

