

QW 37 : modul AA

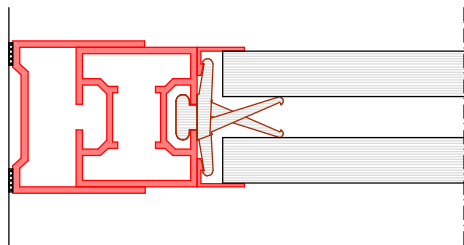

detail A

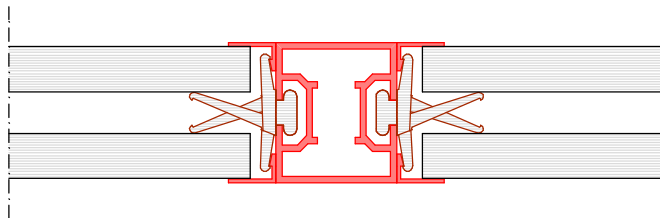

detail B

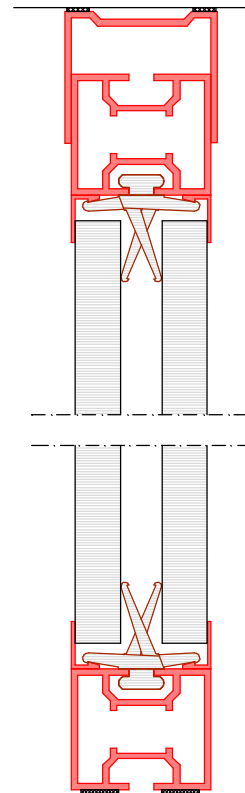

detail C

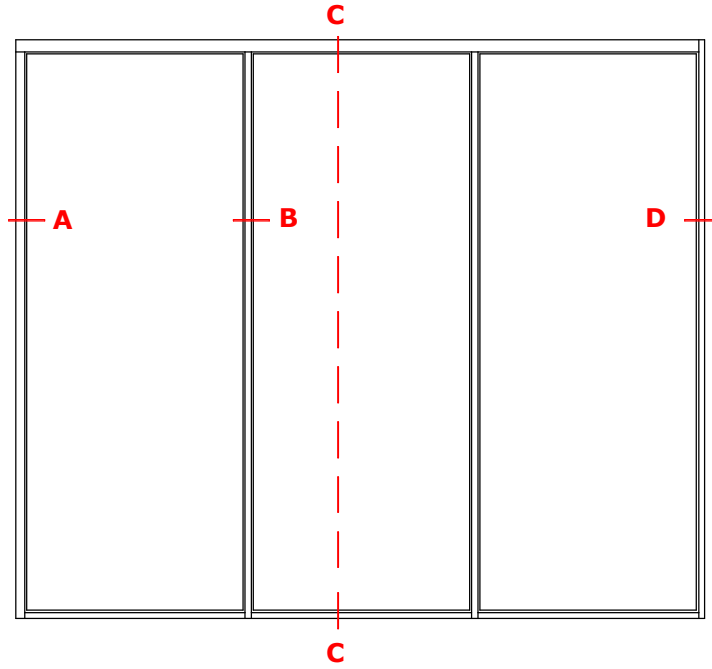

QW 37 : moduul AA-voorzetwand

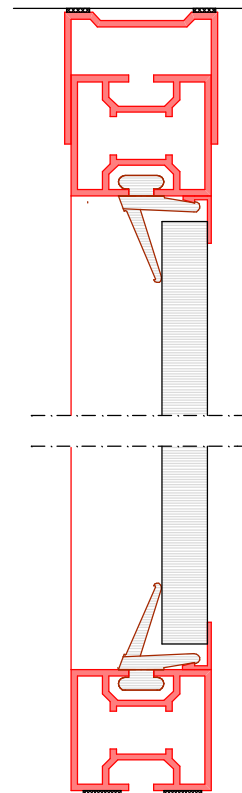
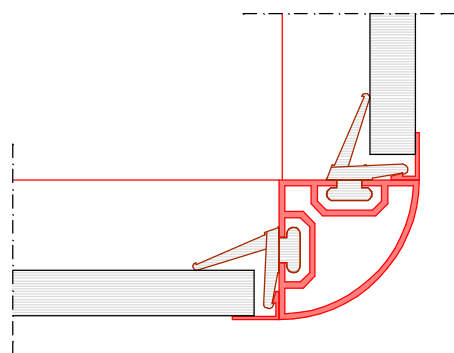
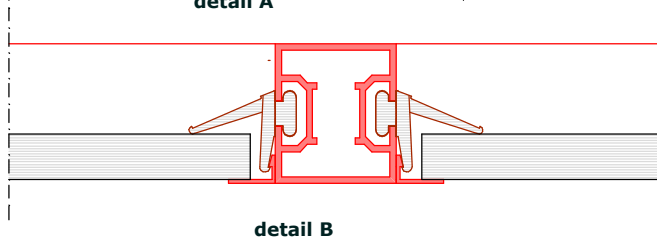
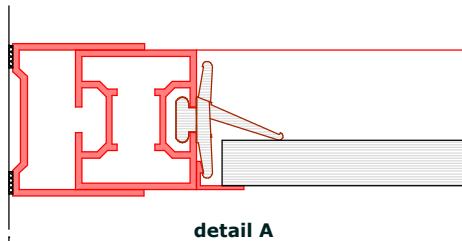

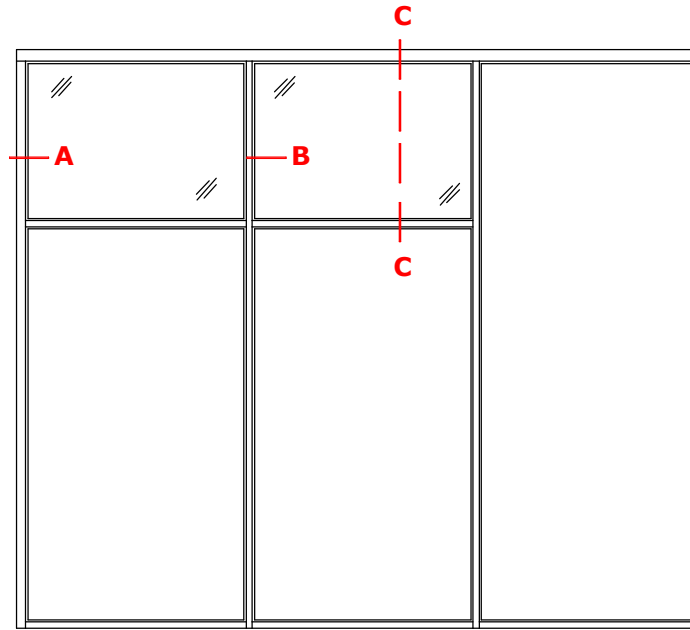

QW 37 : modul BB

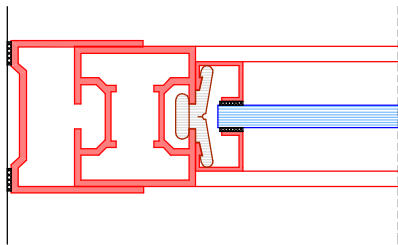

detail A

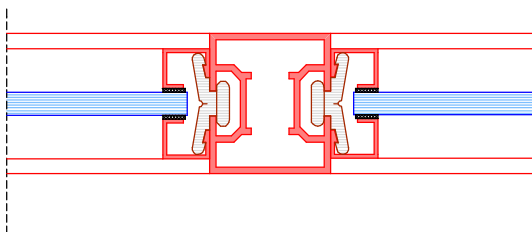

detail B

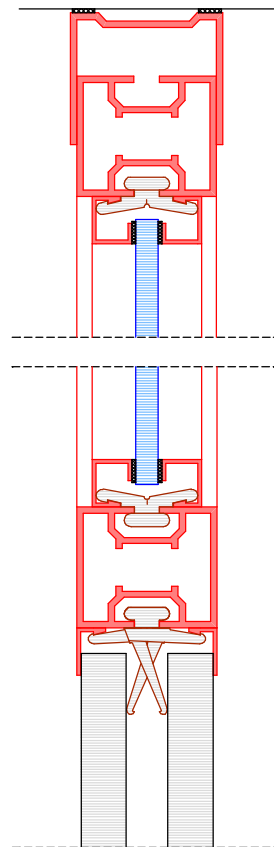

detail C

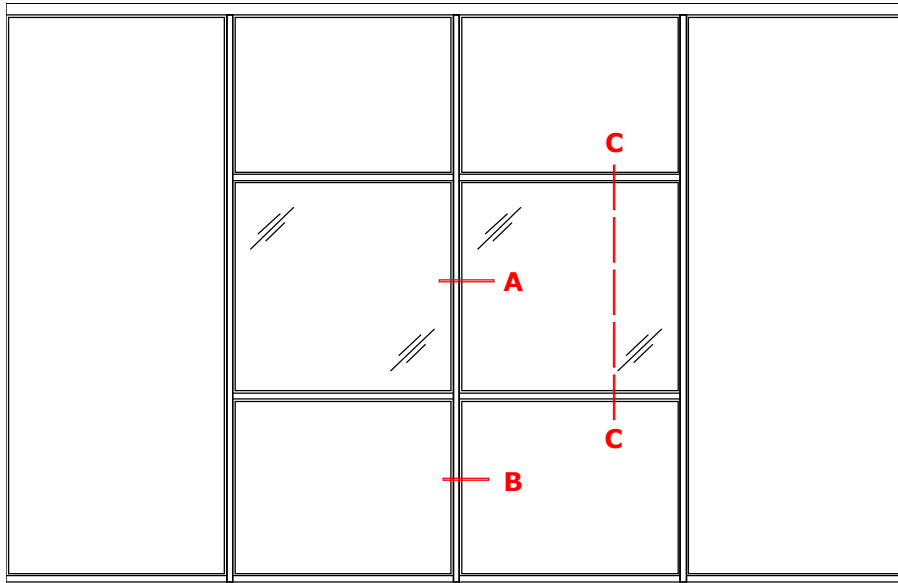

QW 37 : modul CC

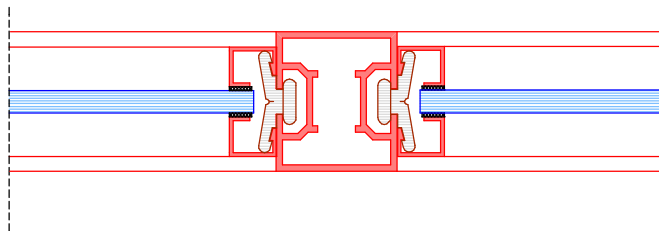

detail A

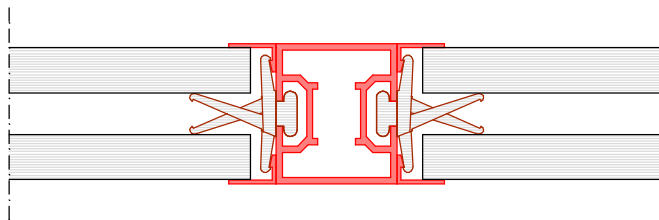

detail B

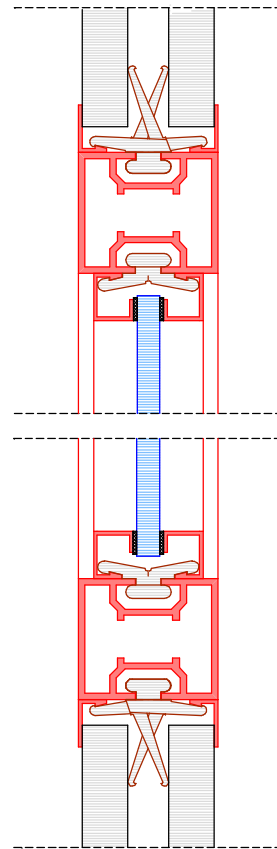

detail C

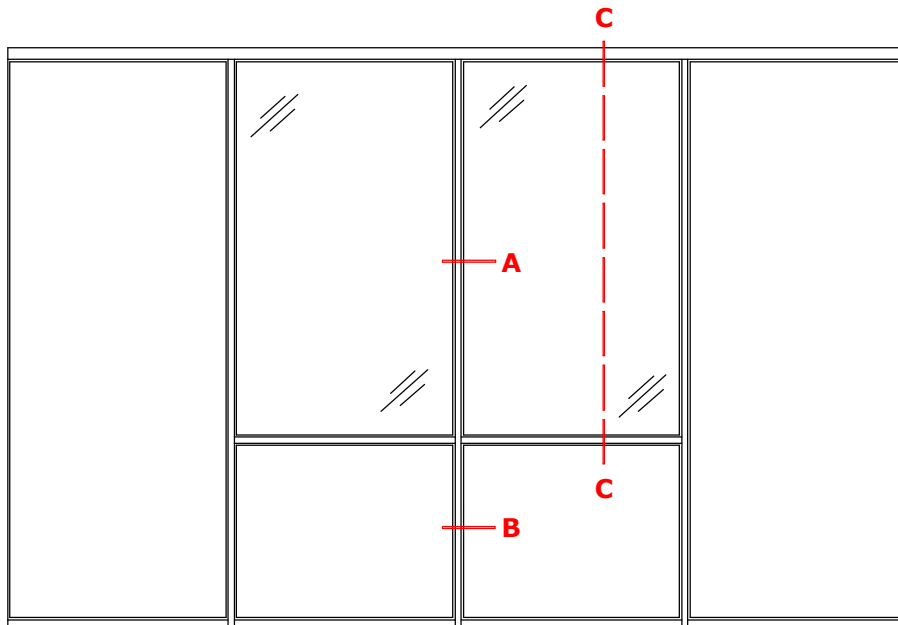

QW 37 : modul EE

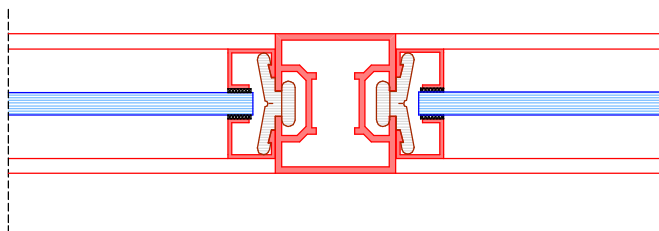

detail A

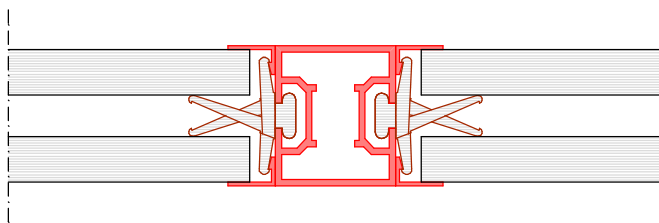

detail B

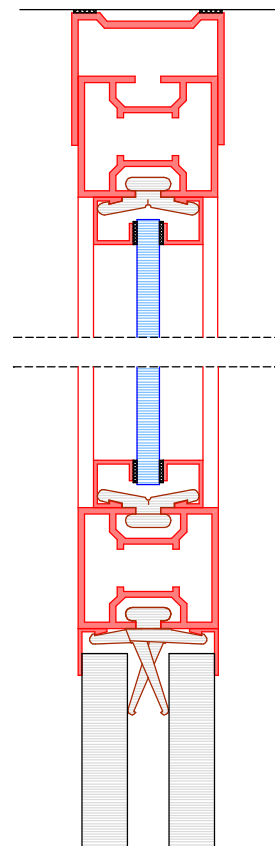

detail C

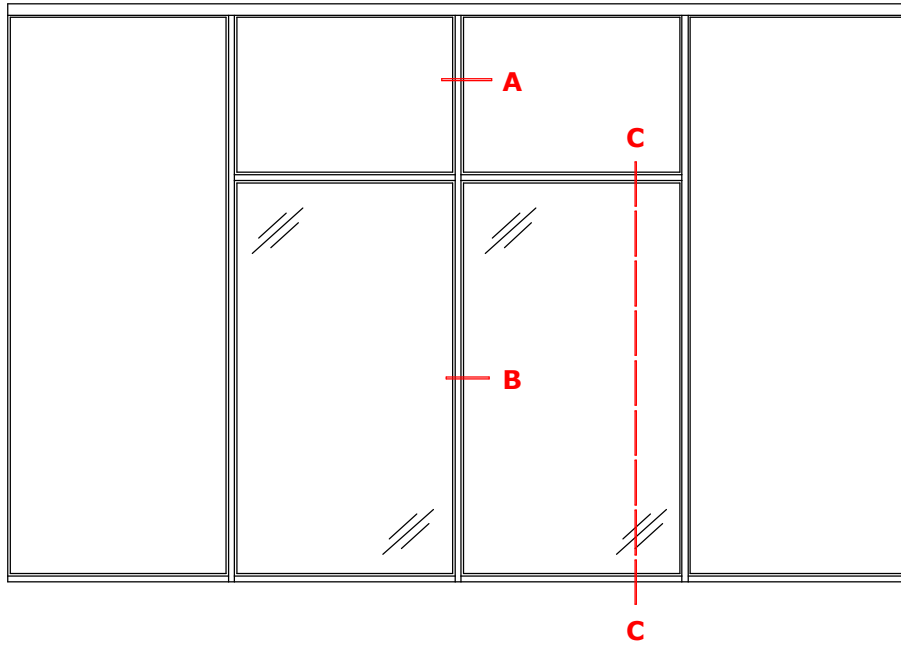

QW 37 : modul EF

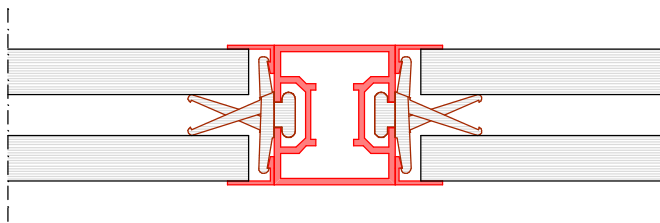

detail A

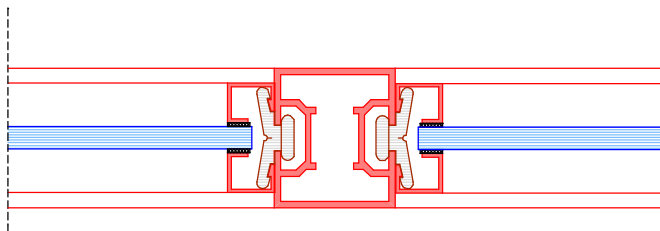

detail B

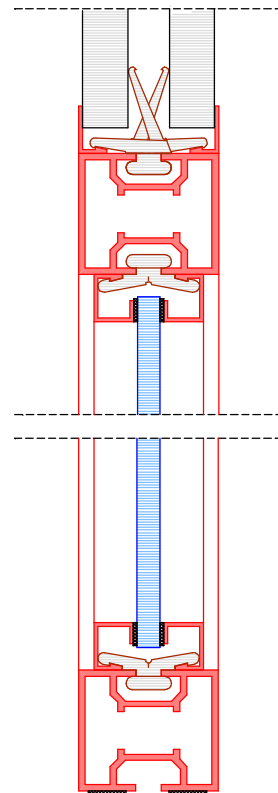

detail C

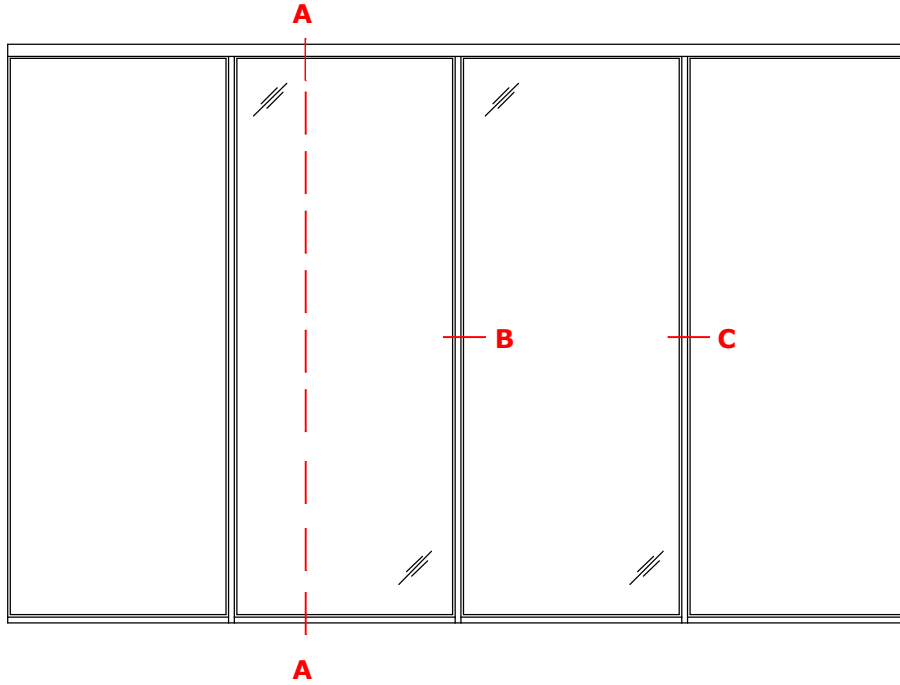

QW 37 : modul AF

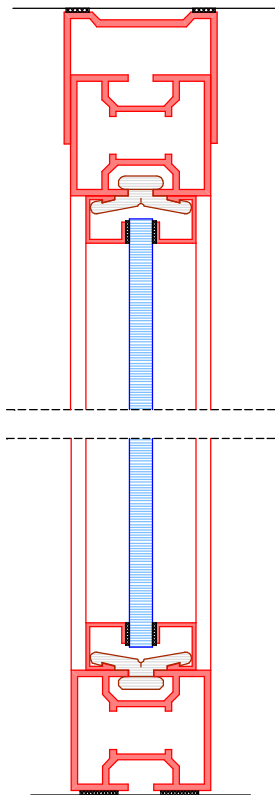

detail A

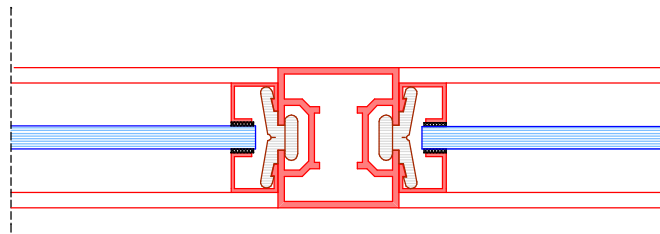

detail B

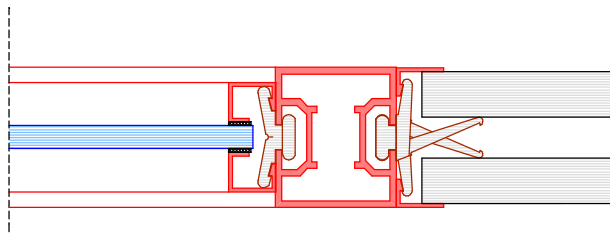

detail C

QW37 | hoekoplossingen | corner solutions | Ecklösungen

